

# User's Manual

LG Programmable Logic Controller

***GLOFA*** G3F – TC4A  
G4F – TC2A  
***MASTER-K*** G6F – TC2A

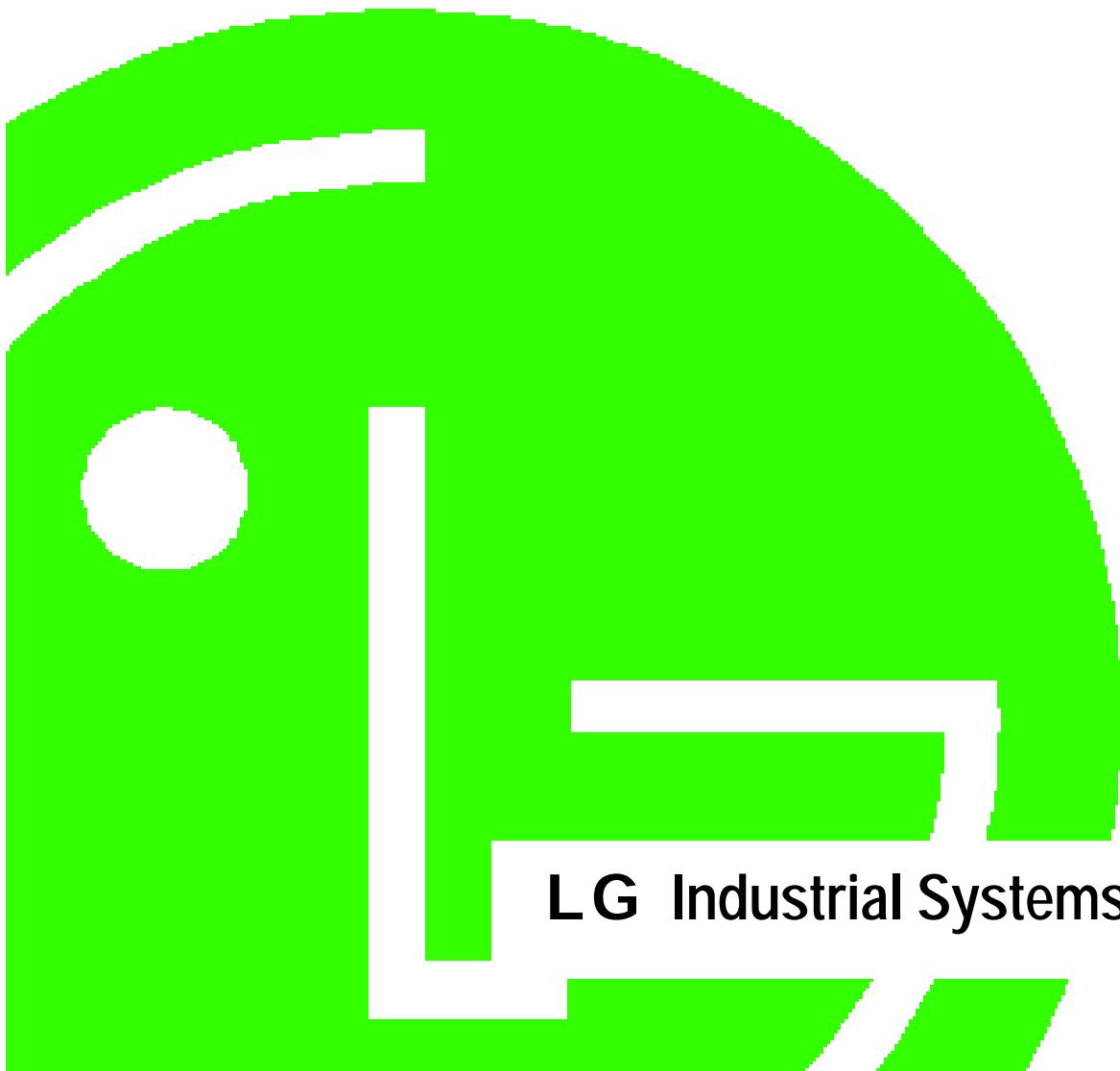

**LG Industrial Systems**

**REVISIONS**

Date	REV. No	Description
2001.4.	702004908	G6F-TC2A Module added



## SAFETY PRECAUTIONS

Be sure to read carefully the safety precautions given in data sheet and user's manual before operating the module and follow them.

The precautions explained here only apply to the G3F-TC4A , G4F-TC2A andG6F-TC2A.

For safety precautions on the PLC system, see the GLOFA GM3/4 User's Manuals, GLOFA GM6 User's Manuals or the MASTER-K 1000S/300S/200S User's Manuals.

A precaution is given with a hazard alert triangular symbol to call your attention, and precautions are represented as follows according to the degree of hazard.

 <b>WARNING</b>	⇒	If not provided with proper prevention, it can cause death or fatal injury or considerable loss of property.
 <b>CAUTION</b>	⇒	If not properly observed, it can cause a hazard situation to result in severe or slight injury or a loss of property.

However, a precaution followed with  **CAUTION** also result in serious conditions.

Both of two symbols indicate that an important content is mentioned, therefore, be sure to observe it.

Keep this manual handy for your quick reference in necessary.

### Design Precautions

#### **CAUTION**

Do not run I/O signal lines and compensating wires near to high voltage line or power line.

Separate them as 100 mm or more as possible.

Otherwise, noise can cause module malfunction.

## Installation Precautions



Operate the PLC in the environment conditions given in the general specifications.

If operated in other environment not specified in the general specifications, it can cause an electric shock, a fire, malfunction or damage or degradation of the module.

Make sure the module fixing projections is inserted into the module fixing hole and fixed.

Improper installation of the module can cause malfunction, disorder or falling.

## Wiring Precautions

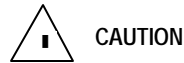

When grounding a FG terminal, be sure to provide class 3 grounding which is dedicated to the PLC.

Before the PLC wiring, be sure to check the rated voltage and terminal arrangement for the module and observe them correctly.

If a different power, not of the rated voltage, is applied or wrong wiring is provided, it can cause a fire or disorder of the module.

Drive the terminal screws firmly to the defined torque.

If loosely driven, it can cause short circuit, a fire or malfunction.

Be careful that any foreign matter like wire scraps should not enter into the module.

It can cause a fire, disorder or malfunction.

## Test Run and Maintenance Precautions



Do not contact the terminals while the power is applied.

It can cause malfunction.

When cleaning or driving a terminal screw, perform them after the power has been turned off.

Do not perform works while the power is applied, which can cause disorder or malfunction.



Do not separate the module from the printed circuit board(PCB), or do not remodel the module.

They can cause disorder, malfunction, and damage of the module or a fire.

When mounting or dismounting the module, perform them after the power has been turned off.

Do not perform works while the power is applied, which can cause disorder or malfunction.

## Waste Disposal Precautions

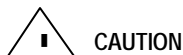

When disposing the module, do it as an industrial waste.

# CONTENTS

## Chapter 1. INTRODUCTION

1.1	Features	1-1
1.2	Glossary	1-2
1.2.1	A-Analog Value	1-2
1.2.2	D-Digital Value	1-2
1.2.3	Compensating Wire	1-2
1.2.4	Thermocouple	1-3
1.2.5	Temperature Conversion Characteristics	1-3
1.2.6	Burn-out Detection	1-3
1.2.7	Reference Junction Compensation (RJC)	1-3

## Chapter 2. SPECIFICATIONS

2.1	General Specifications	2-1
2.2	Performance Specifications	2-2
2.3	Names of Parts and Functions	2-3
2.3.1	G3F-TC4A	2-3
2.3.2	G4F-TC2A	2-4
2.3.3	G6F-TC2A	2-4
2.4	I/O Conversion Characteristics	2-5
2.4.1	Temperature Conversion Characteristics	2-5
2.4.2	Conversion Speed	2-5
2.4.3	Accuracy	2-6
2.4.4	Burn-out Detection	2-6
2.4.5	Displaying Temperature Conversion Value	2-7
2.4.6	Displaying Digital Value	2-7

## Chapter 3. INSTALLATION AND WIRING

3.1	Installation	3-1
3.1.1	Installation Ambience	3-1
3.1.2	Handling Precautions	3-1
3.2	Wiring	3-2
3.2.1	Wiring Precautions	3-2

## Chapter 4. FUNCTIONS BLOCKS

4.1	Insertion of the Function Blocks for Thermocouple Input Module on the GMWIN .....	4-1
4.2	Local Function Block .....	4-2
4.2.1	Module Initialization (G3F-TC4A:TC4INI, G4F-TC2A/G6F-TC2A:TC2INI) .....	4-2
4.2.2	Module Reading (Array Type) (G3F-TC4A:TC4ARD, G4F-TC2A/G6F-TC2A:TC2ARD) .....	4-3
4.2.3	Module Reading (Stand-alone Type) (G3F-TC4A : TC4RD, G4F-TC2A/G6F-TC2A:TC2RD).....	4-4
4.3	Remote Function Block.....	4-5
4.3.1	Module Initialization (G3F-TC4A:TCR4INI, G4F-TC2A:TCR2INI, G6F-TC2A:TCR62INI) .....	4-5
4.3.2	Module Reading (Array Type) (G3F-TC4A:TCR4RD, G4F-TC2A:TCR2RD, G6F-TC2A:TCR62RD) .....	4-6
4.4	Errors Indicated During Execution Of Function Block .....	4-7
4.4.1	Errors Indicated by the Output Variable,STAT .....	4-7
4.4.2	Errors Indicated by the Output Variable,ALM_CODE in the array type temperature Conversion value reading function block(G3F-TC4A:TC4ARD,TCR4RD,G4F-TC2A:TC2ARD,TCR2RD G6F- TC2A:TC2ARD,TCR62RD).....	4-7

## Chapter 5. PROGRAMMING

5.1	A Program for Converting a Detected Temperature Value(° C) into Fahrenheit (° F) and Outputting as a BCD Value .....	5-1
5.2	A Program for Magnitude Comparison of a Detected Temperature Value .....	5-6
5.3	A Program Used When Mounting a Thermocouple Input Module on the Remote I/O Station .....	5-9

## Chapter 6. BUFFER MEMORY CONFIGURATION AND FUNCTIONS

6.1	Buffer Memory Configuration .....	6-1
6.1.1	G3F-TC4A Buffer Memory .....	6-1
6.1.2	G4F-TC2A/G6F-TC2A Buffer Memory .....	6-3
6.2	Buffer Memory Functions .....	6-4
6.2.1	Specifying Channel Enable/Disable (G3F-TC4A : Address 0, G4F-TC2A/G6F-TC2A : Address 0) .....	6-4
6.2.2	Specifying the Type Of Thermocouple (G3F-TC4A : Address 1 To 16, G4F-TC2A G6F-TC2A : Address 1 to 4) .....	6-4
6.2.3	Temperature Conversion Value .....	6-5
6.2.4	Digital Conversion Value .....	6-5
6.2.5	Error Code .....	6-6
6.2.6	Setting SET Data (G3F-TC4A : Address 65, G4F-TC2A G6F-TC2A : Address 17) .....	6-6

6.2.7	Information on Run Channel (G3F-TC4A : Address 66, G4F-TC2A/G6F-TC2A : Address 18)	6-7
6.2.8	Information on Thermocouple Type Specification Error (G3F-TC4A : Address 67, G4F-TC2A /G6F-TC2A : Address 19)	6-7

## Chapter 7. DEDICATED INSTRUCTIONS FOR SPECIAL MODULES (Read from/Write to Buffer Memory)

<b>7.1</b>	<b>Local</b>	<b>7-1</b>
7.1.1	Read from Buffer Memory....GET, GETP	7-1
7.1.2	Write to Buffer Memory.....PUT, PUTP	7-2
<b>7.2</b>	<b>Remote</b>	<b>7-3</b>
7.2.1	Read from Buffer Memory....RGET	7-3
7.2.2	Write to Buffer Memory.....RPUT	7-4

## Chapter 8. PROGRAMMING

<b>8.1</b>	<b>Basic Programming</b>	<b>8-1</b>
8.1.1	G3F-TC4A	8-1
8.1.2	G4F-TC2A	8-2
<b>8.2</b>	<b>Application Programming</b>	<b>8-3</b>
8.2.1	A Program for Converting a Detected Temperature Value(°C) into Fahrenheit(°F) and Outputting as a BCD Value	8-3
8.2.2	A Program for Magnitude Comparison of a Detected Temperature Value	8-5
8.2.3	A Program Used When Mounting a Thermocouple Input Module on the Remote I/O Station	8-7

## Chapter 9. TROUBLESHOOTING

<b>9.1</b>	<b>Errors Indicated by Run LED Flickering</b>	<b>9-1</b>
<b>9.2</b>	<b>Troubleshooting Procedure</b>	<b>9-1</b>
9.2.1	RUN LED Flickering	9-1
9.2.2	RUN LED Off	9-2
9.2.3	Temperature Conversion Value Fluctuates Excessively	9-2
9.2.4	Input Value of the Thermocouple does not Correspond to the Detected Temperature Value	9-3
9.2.5	The LED Display of G3F-TC4A Indicates Error	9-4
9.2.6	Thermocouple Input Module Hardware Defect	9-4

## Chapter 10. DIMENSIONS

<b>10.1</b>	<b>G3F-TC4A Dimensions</b>	<b>10-1</b>
<b>10.2</b>	<b>G4F-TC2A Dimensions</b>	<b>10-2</b>

10.3	G6F-TC2A Dimensions .....	10-3
------	---------------------------	------

## Appendix

### APPENDIX 1

1.1	Thermoelectromotive Force Tables .....	A-1
1.2	Thermocouple .....	A-5
1.2.1	Normal and Overheat Temperature Limits .....	A-5
1.2.2	Temperature Tolerances .....	A-6
1.3	Compensating Wire .....	A-7
1.3.1	Types and Specifications of Compensating Wire .....	A-7

## Chapter 1. INTRODUCTION

This manual is a learning and reference guide for the G3F-TC4A, G4F-TC2A and G6F-TC2A. The G3F-TC4A is a thermocouple input module used with the CPU of GLOFA GM1/2/3 series and MASTERK 1000S series. The G4F-TC2A is used with the CPU of GM4 series and K300S series. The G6F-TC2A is used with the CPU of GM6 series and K200S series. Hereafter, the three modules called thermocouple input module. The thermocouple input module converts a temperature input by a thermocouple (Type K, J, E, T, B, R or S) into a signed 16-bit digital binary data and outputs it.

### 1.1 Features

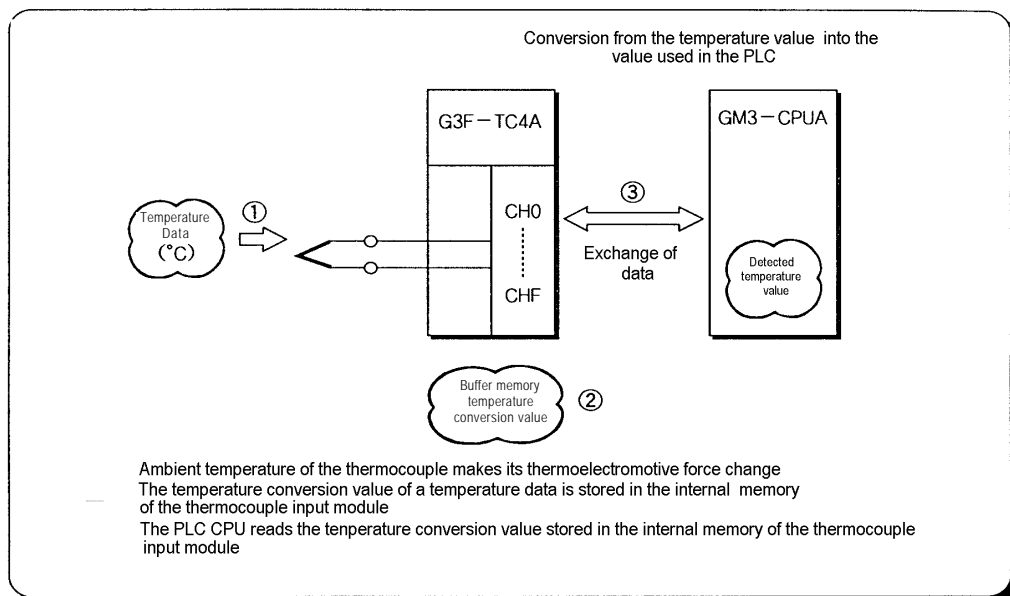

The thermocouple input module has following features.

- 1) With direct connection of one of seven types of thermocouple to the thermocouple input module, a temperature data (°C) can be converted into a digital value to be processed in the PLC
- 2) The temperature data (°C) input can be processed to one digit after the point as a digital value.
- 3) 16 point (G3F-TC4A) or 4-point (G4F-TC2A/G6F-TC2A) of thermocouple can be connected to one module.
- 4) Disconnection and Out-of-range detection function for every channel are included
- 5) The thermocouples in accordance with five specifications (KS, JIS, ANSI, DIN, BS) are available.
- 6) The temperature sensor loaded onto terminal block performs automatic reference junction compensation.

1.2 Glossary

1.2.1 A - Analog Value

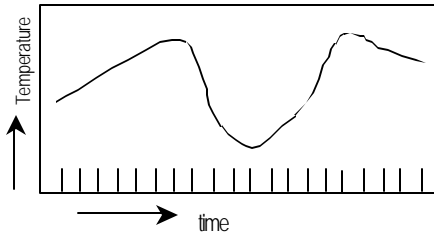

[Fig.1.1] Analog Value

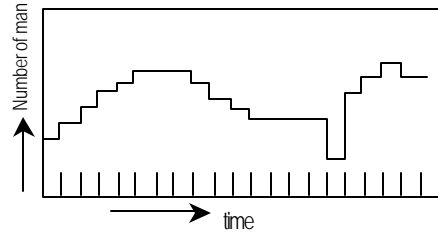

[Fig.1.2] Digital Value

Continuous changeable quantity such as voltage, current, temperature, velocity, pressures and flux is called an analog quantity. For example, temperature changes continuously with time as shown in Fig. 1.1. The PLC can process that continuous changeable temperature by use of the thermocouple input module.

1.2.2 D - Digital Value

In the Fig.1.2, the number of man can be counted as 0, 1, 2 and 3. A discontinuous changeable quantity as such is called a digital quantity. On and Off signals can be denoted as a digital value 0 and 1, respectively.

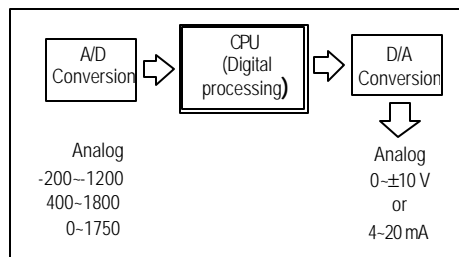

[Fig. 1.3] Processing in the PLC

An analog quantity cannot be directly input to the CPU module for digital processing. Therefore, an analog value should be converted into a digital value to be input to the CPU module. In addition, for external output of an analog quantity, a digital quantity of the CPU module should be converted into an analog quantity.

### 1.2.3 Compensating Wire

This means a wire used to compensate error (temperature change) by the distance between terminal of an input thermocouple and input terminal of a thermocouple input module. This has the thermoelectromotive force characteristics between the two terminals under the temperature of 90 to 150 °C or less.

### 1.2.4 Thermocouple

If two different metals are joined and two different temperatures are applied to the two junctions, the temperature difference generates a thermoelectromotive force between them and thermal current flows. This effect called thermoelectric effect. Thermocouple is a temperature sensor using thermoelectric effect. The magnitude of a thermoelectric force is determined by the type of junction metals and temperature difference between two junctions, and the shape and dimensions of metals and intermediate temperature change do not influence it.

### 1.2.5 Temperature Conversion Characteristics

The thermoelectromotive force to a temperature of a thermocouple has non-linear characteristics, therefore, linear processing should be applied to a A/D conversion digital value and it will be output as a detected temperature value.

### 1.2.6 Burn-out Detection

If a connected thermocouple or compensating wire has disconnection in some part of them, the internal burn out circuit measures an out of range-voltage and then the thermocouple input module detects the disconnection.

### 1.2.7 Reference Junction Compensation (RJC)

As the thermoelectromotive force table of various specifications has 0°C as its reference, the difference between the present temperature at measuring point (input terminal) and the reference temperature (0°C) should be compensated.

## Chapter 2. SPECIFICATIONS

### 2.1 General Specifications

Table 2.1 shows general specifications of the GLOFA GM series and MASTERK series.

No	Items	Specifications	Standard				
1	Operating ambient temperature	0 ~ 55					
2	Storage ambient temperature	-25 ~ 70					
3	Operating ambient humidity	5 ~ 95%RH, non-condensing					
4	Storage ambient humidity	5 ~ 95%RH, non-condensing					
5	Vibration	Occasional vibration				10 times in each direction for X, Y, Z	IEC 61131-2
		Frequency	Acceleration	Amplitude	Sweep		
		10 f 57 Hz	-	0.075 mm			
		57 f 150 Hz	9.8 m/s <sup>2</sup> {1G}	-			
		Continuos vibration					
		Frequency	Acceleration	Amplitude			
10 f 57 Hz	-	0.035 mm					
57 f 150 Hz	4.9 m/s <sup>2</sup> {0.5G}	-					
6	Shocks	*Maximum shock acceleration: 147 m/s <sup>2</sup> {15G} *Duration time :11 ms *Pulse wave: half sine wave pulse( 3 times in each of X, Y and Z directions )				IEC 61131-2	
7	Noise immunity	Square wave impulse noise	± 1,500 V			LGIS Standard	
		Electrostatic discharge	Voltage :4kV(contact discharge)			IEC 61131-2 IEC1000-4-2	
		Radiated electromagnetic field	27 ~ 500 MHz, 10 V/m			IEC 61131-2 IEC 1000-4-3	
		Fast transient burst noise	Severity Level	All power modules	Digital I/Os ( Ue ≥ 24 V)	Digital I/Os (Ue < 24 V) Analog I/Os communication I/Os	IEC 61131-2 IEC1000-4-4
		Voltage	2 kV	1 kV	0.25 kV		
8	Operating atmosphere	Free from corrosive gases and excessive dust					
9	Altitude for use	Up to 2,000m					
10	Pollution degree	2 or lower					
11	Cooling method	Self-cooling					

[Table 2.1] General specifications

#### REMARK

- 1) IEC(International Electrotechnical Commission)  
: The international civilian organization which produces standards for electrical and electronics industry.
- 2) Pollution degree  
: It indicates a standard of operating ambient pollution level.  
The pollution degree 2 means the condition in which normally, only non-conductive pollution occurs.  
Occasionally, however, a temporary conductivity caused by condensation shall be expected.

**2.2 Performance Specifications**

Table 2.2 shows performance specifications of the thermocouple input module.

Item	Specifications																																											
	G3F-TC4A	G4F-TC2A	G6F-TC2A																																									
Connectable thermocouple	Type K, J, E, T, B, R or S thermocouple																																											
Digital output	Digital conversion value : 0 to 16,000 Temperature conversion value : (thermocouple measuring temperature range × 10)																																											
Temperature input range	<table border="1"> <thead> <tr> <th>Thermo-couple type</th> <th>DIN Spec.</th> <th>BS Spec.</th> <th>Measuring temp. range(°C)</th> <th>Measuring voltage range(μV)</th> </tr> </thead> <tbody> <tr> <td>K</td> <td>NiCr-Ni</td> <td>NiCr-NiAl</td> <td>-200.0 ~1200.0</td> <td>-5981~48828</td> </tr> <tr> <td>J</td> <td>-</td> <td>Pe-CuNi</td> <td>-200.0 ~800.0</td> <td>-7890~45498</td> </tr> <tr> <td>E</td> <td>-</td> <td>NiCr-CuNi</td> <td>-150.0 ~600.0</td> <td>-7297~45085</td> </tr> <tr> <td>T</td> <td>-</td> <td>Cu-CuNi</td> <td>-200.0 ~400.0</td> <td>-5602~20869</td> </tr> <tr> <td>B</td> <td>-</td> <td>PtRh30-PtRh6</td> <td>400.0 ~1800.0</td> <td>786~13585</td> </tr> <tr> <td>R</td> <td>-</td> <td>PtRh13-Pt</td> <td>0.0 ~1750.0</td> <td>0~21006</td> </tr> <tr> <td>S</td> <td>PtRh-Pt</td> <td>PtRh10-Pt</td> <td>0.0 ~1750.0</td> <td>0~18612</td> </tr> </tbody> </table>				Thermo-couple type	DIN Spec.	BS Spec.	Measuring temp. range(°C)	Measuring voltage range(μV)	K	NiCr-Ni	NiCr-NiAl	-200.0 ~1200.0	-5981~48828	J	-	Pe-CuNi	-200.0 ~800.0	-7890~45498	E	-	NiCr-CuNi	-150.0 ~600.0	-7297~45085	T	-	Cu-CuNi	-200.0 ~400.0	-5602~20869	B	-	PtRh30-PtRh6	400.0 ~1800.0	786~13585	R	-	PtRh13-Pt	0.0 ~1750.0	0~21006	S	PtRh-Pt	PtRh10-Pt	0.0 ~1750.0	0~18612
Thermo-couple type	DIN Spec.	BS Spec.	Measuring temp. range(°C)	Measuring voltage range(μV)																																								
K	NiCr-Ni	NiCr-NiAl	-200.0 ~1200.0	-5981~48828																																								
J	-	Pe-CuNi	-200.0 ~800.0	-7890~45498																																								
E	-	NiCr-CuNi	-150.0 ~600.0	-7297~45085																																								
T	-	Cu-CuNi	-200.0 ~400.0	-5602~20869																																								
B	-	PtRh30-PtRh6	400.0 ~1800.0	786~13585																																								
R	-	PtRh13-Pt	0.0 ~1750.0	0~21006																																								
S	PtRh-Pt	PtRh10-Pt	0.0 ~1750.0	0~18612																																								
Reference junction compensation	Automatic compensation																																											
Burn-out detection	Every channel has detected.																																											
Accuracy	±[ Full scale × 0.3 % + 1°C (Reference junction compensation tolerance)]																																											
Maximum conversion speed	50 ms per channel																																											
Number of temperature input channel	16 channels per module	4 channels per module	4 channels per module																																									
Insulation method	Photo-coupler insulation between the input terminal and the PLC power supply (non-insulation between channels)																																											
Connection terminal block	38-point terminal block	20-point terminal block	18-point terminal block																																									
Internal current consumption	+5V : 450 mA	+5V : 450 mA	+5V : 100 mA +15V : 40 mA -15V : 20 mA																																									
Weight	640 g	360 g	170 g																																									

[Fig. 2.2] Performance Specifications

**2.3 Names of Parts and Functions**

The following gives names of parts :

**2.3.1 G3F-TC4A**

The following gives the names and functions of each part of the G3F-TC4A.

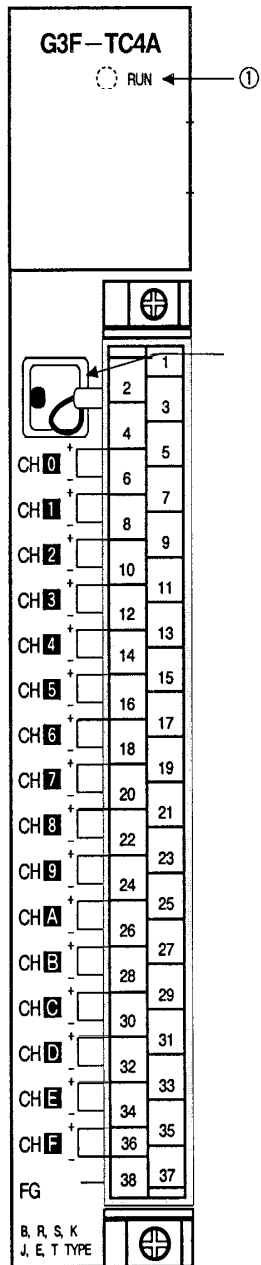

No	Contents
	<p><b>RUN LED</b></p> <p>It displays the operating status of G3F-TC4A</p> <ul style="list-style-type: none"> <li>● On : Normal Operation</li> <li>● Flickering: Error occurred (For details, refer to Troubleshooting Section 9.1)</li> <li>● Off : 5 VDC disconnection or the G3F-TC4A module HW error</li> </ul>
	<p><b>Reference junction compensation device</b></p> <p>Reference junction compensation for type K, J, E, T, R or S.</p>

2.3.2 G4F-TC2A

The following gives the names and functions of each part of the G4F-TC2A.

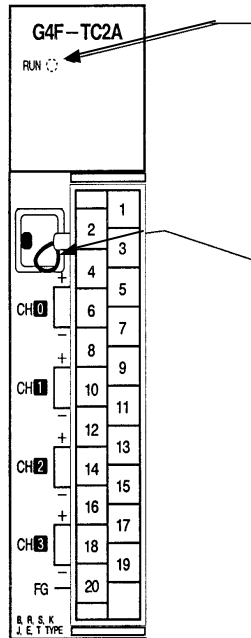

No	Contents
	<p><b>RUN LED</b></p> <p>It displays the operating status of G4F-TC2A</p> <ul style="list-style-type: none"> <li>● On : Normal Operation</li> <li>● Flickering: Error occurred (For details, refer to Troubleshooting Section 9.1)</li> <li>● Off : 5 VDC disconnection or the G4F-TC2A module HW error</li> </ul> <p><b>Reference junction compensation device</b></p> <p>Reference junction compensation for type K, J, E, T, R or S.</p>

2.3.3 G6F-TC2A

The following gives the names and functions of each part of the G6F-TC2A.

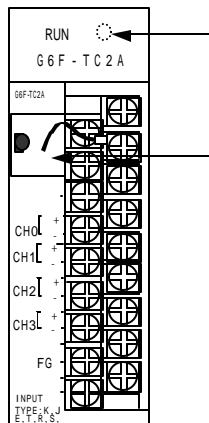

No	Contents
	<p><b>RUN LED</b></p> <p>It displays the operating status of G6F-TC2A</p> <ul style="list-style-type: none"> <li>● On : Normal Operation</li> <li>● Flickering: Error occurred (For details, refer to Troubleshooting Section 9.1)</li> <li>● Off : 5 VDC disconnection or the G6F-TC2A module HW error</li> </ul> <p><b>Reference junction compensation device</b></p> <p>Reference junction compensation for type K, J, E, T, R or S.</p>

**2.4 I/O Conversion Characteristics**

The temperature that the thermocouple detected is input to each channel as a thermoelectromotive force. Every channel is scanned at every measuring cycle and each input voltage is output as a temperature conversion value through A/D conversion.

**2.4.1 Temperature Conversion Characteristics**

The thermocouple input module performs A/D conversion of the non-linear characteristic thermocouple input value and outputs the linear-processed temperature conversion value. The following Fig. 2.1 shows an example of characteristics of the temperature conversion value to the thermocouple input value.

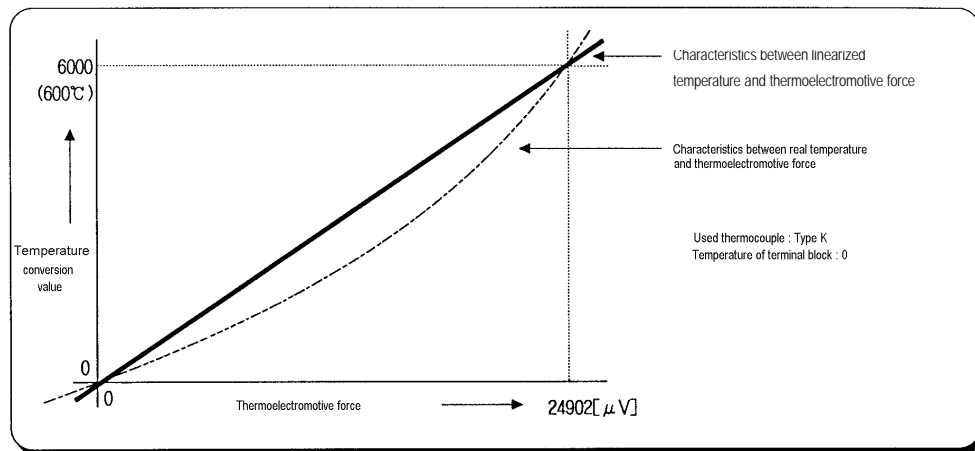

[Fig. 2.1] Temperature conversion characteristics

**2.4.2 Conversion Speed**

The conversion speed of the thermocouple input module is 50 ms per channel and its processing is processed sequentially, that is, one channel is processed and then another channel is processed.

Measuring cycle = 50 ms × (the number of conversion enabled channels)

Example) When 10 channels are used in the G3F-TC4A

Measuring cycle = 50 ms × 10 = 500 ms

That is, at every interval of 500ms, every thermocouple input value of every channel is A/D converted and output as a temperature conversion value

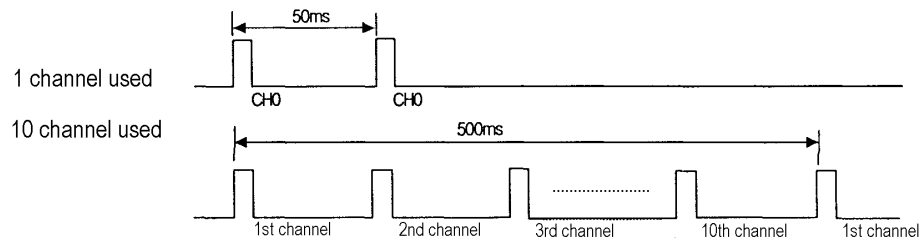

### 2.4.3 Accuracy

The accuracy of the thermocouple input module is within  $\pm 0.3\%$  of all of the measuring temperature range and error ( $\pm 1^\circ\text{C}$ ) from reference junction compensation is added.

Example) When a thermocouple type K is used, the detected temperature values to temperatures  $-200^\circ\text{C}$ ,  $500^\circ\text{C}$  and  $1200^\circ\text{C}$  are as below.

- Overall measuring temperature range of the K type:  $1400^\circ\text{C}$  ( $-200.0^\circ\text{C}$  to  $1200.0^\circ\text{C}$ )
- Accuracy of the K type:  $1400^\circ\text{C} \times \pm 0.003 = \pm 4.2^\circ\text{C}$
- Accuracy including the error of reference junction compensation:  $4.2 \pm 1 = \pm 5.2^\circ\text{C}$
- Temperature conversion range :  $-205.2^\circ\text{C}$  to  $-194.8^\circ\text{C}$  when  $-200^\circ\text{C}$   
 $494.8^\circ\text{C}$  to  $505.2^\circ\text{C}$  when  $500^\circ\text{C}$   
 $1294.8^\circ\text{C}$  to  $1205.2^\circ\text{C}$  when  $1200^\circ\text{C}$

### 2.4.4 Burn-out Detection

This function detects disconnection of the thermocouple or compensating wire connected to the thermocouple input module. As shown in the Fig. 2.2, if disconnection occurs in the thermocouple or compensating wire the internal disconnection detection circuit measures an out-of-range voltage and occurs disconnection error codes. Disconnection detection function is automatically performed on every channel.

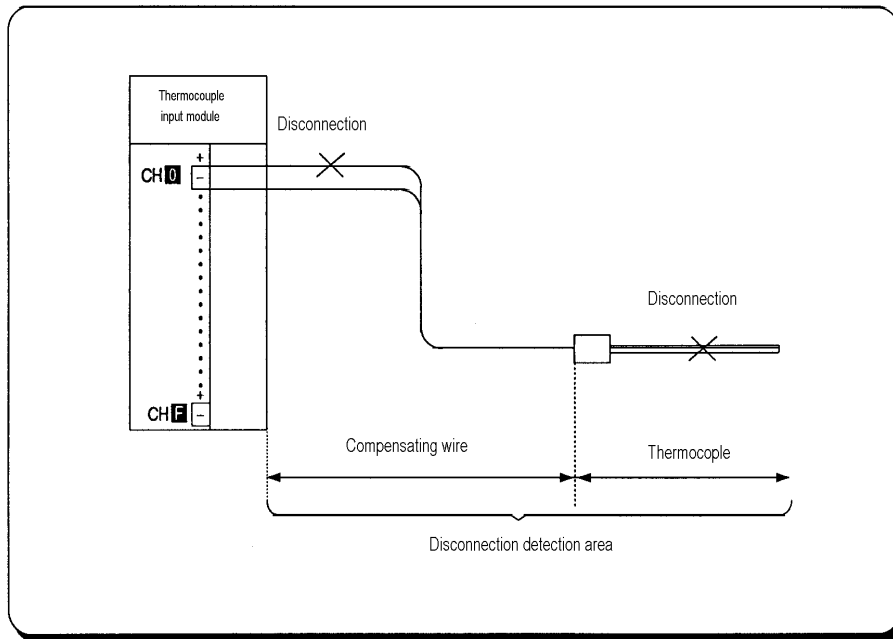

[Fig. 2.2] Disconnection Detection Area

### 2.4.5 Displaying Temperature Conversion Value

The detected temperature value converted into through sampling processing of a thermocouple input value times by ten and that is displayed as a digital value, which is called temperature conversion value.

[Example] When a real temperature is 100.5°C

- Detected temperature value : 1005  
( Digital value stored in the output variable TEMP of the reading function block.  
Digital value stored in the internal memory)

### 2.4.6 Displaying Digital Value

The thermocouple input module gives a digital value which has been calculated from a temperature value to be suitable for process control of the PID control module. This value can be used as an input value (Process Value) in the PID control module.

Thermocouple type	Type K	Type J	Type E	Type T	Type B	Type R	Type S
Overall measuring temp. range	14000 (-2000 to 12000)	10000 (-2000 to 8000)	7500 (-1500 to 6000)	6000 (-2000 to 4000)	14000 (4000 to 18000)	17500 (0 to 17500)	17500 (0 to 17500)
Minimum measuring temperature	-2000	-2000	-1500	-2000	4000	0	0

$$\text{Digital value} = \frac{16000}{\text{Overall measuring temperature range}} (\text{temperature conversion value} - \text{minimum measuring temperature})$$

[Example 1] Digital value when a real temperature is 400°C of thermocouple type J.

$$\begin{aligned} \text{Digital value} &= \frac{16000}{10000} [4000 - (-2000)] \\ &= 9600 \end{aligned}$$

[Example 2] Digital value when a real temperature is 700°C of thermocouple type K.

$$\begin{aligned} \text{Digital value} &= \frac{16000}{14000} [7000 - (-2000)] \\ &= 10285.71428571 \text{ (round off at first digit of fraction)} \\ &= 10268 \end{aligned}$$

## Chapter 3. INSTALLATION AND WIRING

### 3.1 Installation

#### 3.1.1 Installation Ambience

This module has high reliability regardless of its installation ambience. But be sure to check the following for system in higher reliability and stability.

##### 1) Ambience Requirements

Avoid installing this module in locations, which are subjected or exposed to:

- Water leakage and dust a large amount of dust, powder and other conductive power, oil mist, salt, of organic solvent exists.
- Mechanical vibrations of impacts are transmitted directly to the module body.
- Direct sunlight.
- Dew condensation due to sudden temperature change.
- High or low temperatures (outside the range of 0 to 55 °C)

##### 2) Installing and Wiring.

- During wiring or other work do not allow any wire scraps to enter into it.
- Install it on locations that are convenient for operation.
- Make sure that it is not located near high voltage equipment located.
- Make sure that the distance from the walls of duct and external equipment be 50 mm or more.
- Be sure to be grounded to locations that have good ambient noise immunity.

#### 3.1.2 Handling Precautions

From unpacking to installing the thermocouple input module, be sure to check the following:

- 1) Do not drop it off, and make sure that strong impacts should not be applied.
- 2) Do not dismount printed circuit boards from the case. It can cause malfunctions.
- 3) During wiring, be sure to check any foreign matter like wire scraps should not enter into the upper side of the module, and in the event that foreign matter entered into it, always eliminate it.
- 4) Be sure to disconnect electrical power before mounting or dismounting the module.

## 3.2 Wiring

### 3.2.1 Wiring Precautions

- 1) Be sure to use compensating wire for sensor input wire and connect shield wire to the terminal FG and ground.
- 2) Be sure to separate the external input signal of the temperature conversion module from an alternating current so that surge or induction noise generated from the alternating current could not effect.
- 3) When wiring, locating this unit too near from high temperature generating devices or materials or contacting it with the material like oil can cause short-circuit and occur damage or disorder.
- 4) When wiring to the terminal block, wiring with high-pressure wire or power supply wire can cause flow inhibition and cause disorder or malfunction.

### 3.2.2 Wiring Example

A wiring example of the thermocouple input module is given below.

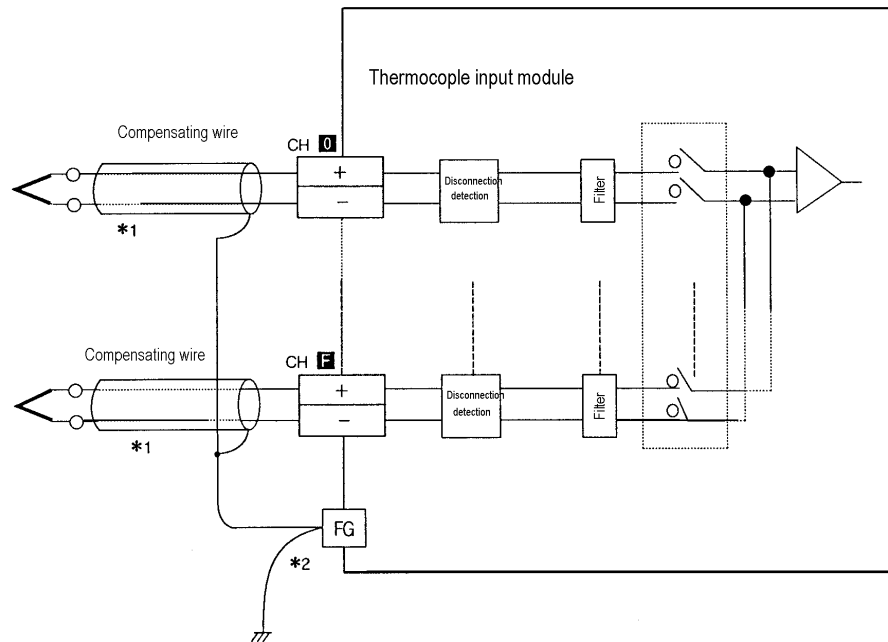

- \*1 Use compensating wire as cable.
- \*2 Connect shield wire part of compensating wire to the terminal FG and ground.

## Chapter 4. FUNCTION BLOCKS

The followings explain the function blocks for the thermocouple input module used on the GMWIN  
The types of function block are given here.

No	G3F - TC4A		G4F - TC2A		G6F - TC2A		Function
	Local	Remote	Local	Remote	Local	Remote	
1	TC4INI	TCR4INI	TC2INI	TCR2INI	TC2INI	TCR62INI	Module Initialization
2	TC4ARD	TCR4RD	TC2ARD	TCR2RD	TC2ARD	TCR62RD	Reading the temperature conversion value (Array type)
3	TC4RD	-	TC2RD	-	TC2RD	-	Reading the temperature conversion value (Single type)

### 4.1 Insertion of the Function Blocks for the Thermocouple Input Module on the GMWIN.

Function blocks can be registered with the following procedure while the GMWIN is running.  
Insertion of the function blocks is only possible when a project is open.

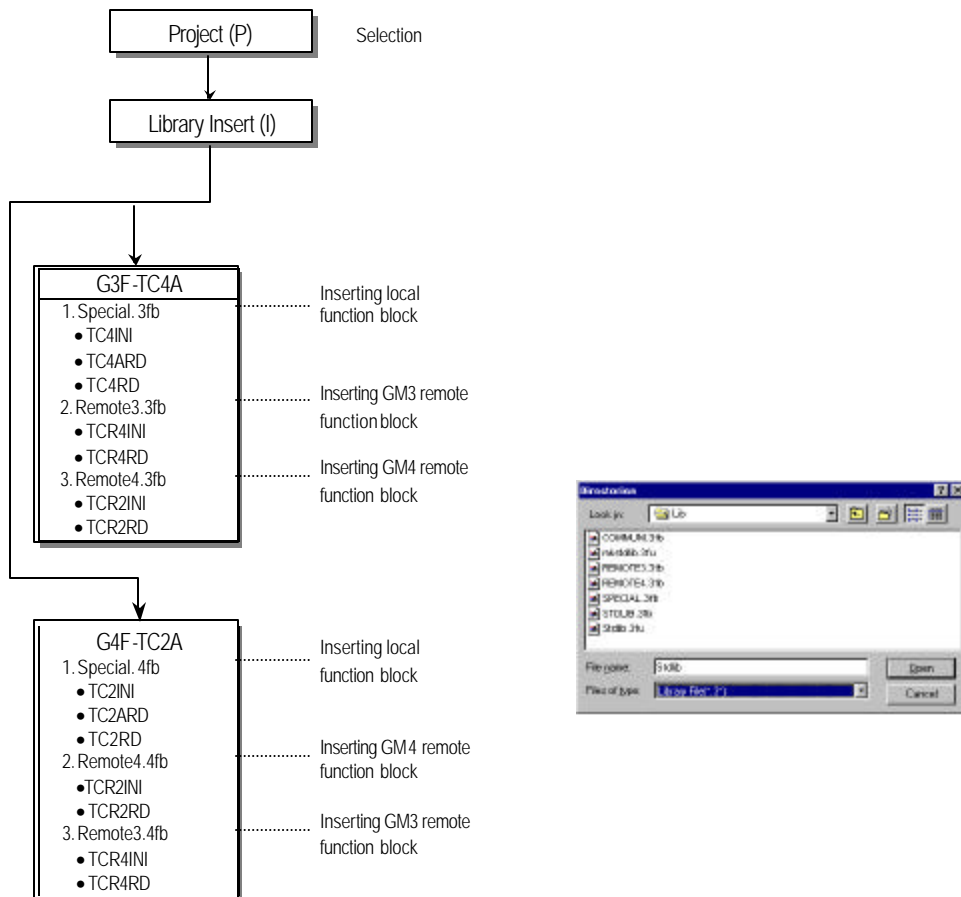

**4.2 Local Function Block**

**4.2.1 Module Initialization (G3F-TC4A: TC4INI, G4F-TC2A/G6F-TC2A:TC2INI)**

Module initialization function block specifies thermocouple input module base location, slot location, run channel enable/disable and the type of thermocouple for use in program.

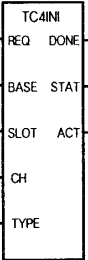
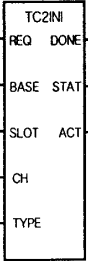
Function Block	I/O	Variable	Data Type	Description																						
<b>G3F – TC4A</b> 	I	REQ	BOOL	Function block execution request area - Used to request an execution of the initialization function block - If the conditions connected with this area are established and "0" changes into "1" while program is running, the initialization function block is executed																						
		BASE	USINT	Base location No. - Used to write the base No. where the thermocouple input module is mounted. - Setting range: GM1 series(0-31), GM2 series(0-7), GM3/4 series(0-3), GM6 series(0-1)																						
		SLOT	USINT	Slot location No. - Used to write the slot No. where the thermocouple input module is mounted. - Setting range: 0-7																						
		CH	BOOL [Array] *Note 1	Used channel enable/disable specification - Used to enable or disable a channel for run. - Specify "1" for enabling, and "0" for disabling																						
		TYPE	USINT [Array] *Note 1	Specifying the type of the sensor to be connected <table border="1" data-bbox="743 1024 1222 1234"> <thead> <tr> <th>Input specification No.</th> <th>Sensor type</th> <th>Temperature range</th> </tr> </thead> <tbody> <tr> <td>0</td> <td>K</td> <td>-200.0 to 1200.0°C</td> </tr> <tr> <td>1</td> <td>J</td> <td>-200.0 to 800.0°C</td> </tr> <tr> <td>2</td> <td>E</td> <td>-150.0 to 600.0°C</td> </tr> <tr> <td>3</td> <td>T</td> <td>-200.0 to 400.0°C</td> </tr> <tr> <td>4</td> <td>B</td> <td>400.0 to 1800.0°C</td> </tr> <tr> <td>5</td> <td>R</td> <td>0.0 to 1750.0°C</td> </tr> <tr> <td>6</td> <td>S</td> <td>0.0 to 1750.0°C</td> </tr> </tbody> </table>	Input specification No.	Sensor type	Temperature range	0	K	-200.0 to 1200.0°C	1	J	-200.0 to 800.0°C	2	E	-150.0 to 600.0°C	3	T	-200.0 to 400.0°C	4	B	400.0 to 1800.0°C	5	R	0.0 to 1750.0°C	6
Input specification No.	Sensor type	Temperature range																								
0	K	-200.0 to 1200.0°C																								
1	J	-200.0 to 800.0°C																								
2	E	-150.0 to 600.0°C																								
3	T	-200.0 to 400.0°C																								
4	B	400.0 to 1800.0°C																								
5	R	0.0 to 1750.0°C																								
6	S	0.0 to 1750.0°C																								
<b>G4F-TC2A/ G6F-TC2A</b> 	O	DONE	BOOL	Function block finished execution status - "1" is output when the initialization function block is finished with no error and "1" remains until next execution. If an error occur, '0' is displayed and the operation enters into the stop state.																						
		STAT	USINT	Error status indication area - Used to output the error No. when it occurs during initialization function block execution. - For description of errors, refer to the Section 4.4																						
		ACT	BOOL [Array] *Note 1	Run channel status indication area - After the initialization function block is finished with no error, "1" is output if the channel is in normal state. But "0" is output for the disabled channels.																						

**REMARK**  
 \*Note 1 [Array]  
 : The numbers of Array are 16 in G3F-TC4A, 4 in G4F-TC2A/G6F-TC2A.

4.2.2 Module Reading (Array type) (G3F-TC4A : TC4ARD, G4F-TC2A/G6F-TC2A : TC2ARD)

The Array type module reading function block executes all channels of the thermocouple input module in batch processing. If a channel is enabled then the function block outputs the temperature conversion value to the output value TEMP.

Function Block	I/O	Variable	Data Type	Description
<b>G3F-TC4A</b> <div style="border: 1px solid black; padding: 2px; margin: 5px 0;">                     TC4ARD                      REQ DONE                      BASE STAT                      SLOT ACT                      CH ALM                      ALM CODE                      TEMP                      SCAL                 </div>	I	REQ	BOOL	Function block execution request area - Used to request an execution of the reading function block - If the conditions connected with this area are established while the program is running and "0" changes into "1", the reading function block is executed.
		BASE	USINT	Base location No. - Used to write the base No. where the thermocouple input module is mounted. - Setting range: GM1 series(0-31), GM2 series(0-7), GM3/4 series(0-3), GM6 series(0-1)
		SLOT	USINT	Slot location No. - Used to write the slot No. where the thermo couple input module is mounted. - Setting range: 0-7
		CH	BOOL [Array] *Note 1	Run channel enable/disable specification - Used to enable or disable a channel for run. - Specify "1" for enabling, and "0" for disabling
	O	DONE	BOOL	Function block finished execution status - "1" is output when the reading function block is finished with no error and "1" remains until next execution. If an error occur, '0' is displayed and the operation enters into the stop state.
		STAT	USINT	Error status indication area - Used to output the error No. when it occurs during reading function block execution. - For description of errors, refer to Section 4.4
		ACT	BOOL [Array] *Note 1	Run channel status indication area - After the reading function block is finished with no error, "1" is output if the channel is in normal state. But "0" is output for the disabled channels.
		ALM	BOOL [Array] *Note 1	Run channel error indication area - "1" is outputted when error occurs for each run channel.
		ALM CODE	USINT [Array] *Note 1	Run channel error code area - Outputs the following code for each channel coded if error occurred. { 0: Normal 16: Disconnection detected 17: Out-of-the-measuring-range error 18: Reference junction compensation device error }
		TEMP	INT [Array] *Note 1	Temperature conversion value output area - The CPU module reads the temperature conversion value of the corresponding channel from the thermocouple input module and outputs it to this area. - The temperature conversion value of each channel is 10 times than the real temperature value. - (Example: Temperature conversion value 1234 → Real temperature value 123.4°C)
<b>G4F-TC2A/ G6F-TC2A</b> <div style="border: 1px solid black; padding: 2px; margin: 5px 0;">                     TC2ARD                      REQ DONE                      BASE STAT                      SLOT ACT                      CH ALM                      ALM CODE                      TEMP                      SCAL                 </div>	O	SCAL	INT [Array] *Note 1	Digital conversion value output area - The CPU module reads the digital conversion value of the corresponding channel from the thermocouple input module and outputs it to this area. - The temperature conversion value of each channel within its measuring temperature range is converted into a digital value within 0 to 16000 and it is outputted to this area. - The Value read from the output variable SCAL. $\frac{\text{Overall measuring temperature range}}{16000} \times (\text{Temperature conversion value} - \text{Minimum measuring temperature})$ - The output value through digital conversion can be used as a PV of the PID control module.

**REMARK**

\* Note 1: The numbers of Array are 16 in G3F-TC4A, 4 in G4F-TC2A/G6F-TC2A.

4.2.3 Module Reading (Stand-alone type)

The stand-alone type module reading function block outputs the temperature conversion value to which each channel of the thermocouple input module is set to output variable TEMP.

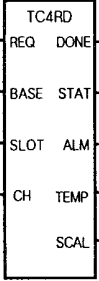
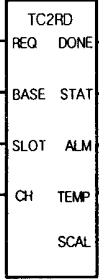
Function Block	I/O	Variable	Data Type	Description
<b>G3F – TC4A</b> 	I	REQ	BOOL	Function block execution request area - Used to request an execution of the conversion value reading function block - If the conditions connected with this area are established and "0" changes into "1" while the program is running, the reading function block is executed. Base location No. - Used to write the base No. where the thermocouple input module is mounted. - Setting range: GM1 series(0-31), GM2 series(0-7), GM3/4 series(0-3) GM6 series(0-1)
		BASE	USINT	Slot location No. - Used to write the slot No. where the thermocouple input module is mounted. - Setting range: 0-7
		SLOT	USINT	Specifying the use channel. Setting range : 0 to 15 (G4F -TC2A/G6F-TC2A: 0 to 3)
		CH	USINT	
<b>G4F-TC2A/ G6F-TC2A</b> 	O	DONE	BOOL	Function block finished execution status - "1" is output when the reading function block is finished without error and "1" remains until next execution. If an error occur, "0" is output and the operation enters into the stop state.
		STAT	USINT	Error status indication area - Used to output the error No. when it occurs during reading function block execution. - For description of errors, refer to the Section 4.4
		ALM	BOOL	Run channel error indication area - "1" is output when error occurs for corresponding run channel.
		TEMP	INT	Temperature conversion value output area - The CPU module reads the temperature conversion value of the corresponding channel from the thermocouple-input module and outputs it to this area. - The temperature conversion value of corresponding channel is 10 times than the real temperature value. (Example: Temperature conversion value 1234 → Real temperature value 123.4°C)
		SCAL	INT	Digital conversion value output area - The CPU module reads the digital conversion value of the corresponding channel from the thermocouple input module and outputs it to this area. - The temperature conversion value of corresponding channel within its measuring temperature range is converted into a digital value within 0 to 16000 and it is outputted to this area. - The Value read from the output variable SCAL. $\frac{16000}{\text{Overall measuring temperature range}} \times (\text{Temperature conversion value} - \text{Minimum measuring temperature})$ - The output value through digital conversion can be used as a PV of the PID control module.

**4.3 Remote Function Block**

**4.3.1 Module Initialization (G3F-TC4A : TCR4INI, G4F-TC2A : TCR2INI, G6F-TC2A : TCR62INI)**

The module initialization function block specifies, for use in the program, the local communications module slot location No. of the thermocouple input module, and the station No., base No. and slot location No. of the communications module loaded in remote I/O station. And it specifies used channels and the type of the thermocouple.

Function Block	I/O	Variable	Data Type	Description																						
<b>G3F-TC2A</b> 	I	REQ	BOOL	Function block execution request area - Used to request an execution of the writing function block - If the conditions connected with this area are established while the program is running and "0" changes into "1" (  ), the initialization function block is executed.																						
		NET_NO	USINT	Location No. of the slot where the local communication module to which the function block will be sent is mounted. - Setting range: 0 ~ 7																						
		ST_NO	USINT	Station No. of the communication module mounted in the remote I/O station. - Setting range: 0 ~ 63																						
		BASE	USINT	Base location No. - Used to write the base No. where the thermocouple input module is mounted. - Setting range: GM1 series(0-31), GM2 series(0-7), GM3/4 series(0-3) GM6 series(0-1)																						
		SLOT	USINT	Slot location No. - Used to write the slot No. where the thermocouple input module is mounted. - Setting range: 0-7																						
<b>G4F-TC2A</b> 	I	CH	BOOL [Array] *Note 1  USINT [Array] *Note 1	Used channel enable/disable specification - Used to enable or disable a channel for run. - Specify "1" for enabling, and "0" for disabling Specifying the type of used sensor - Used to specify the type of sensor used at each channel																						
		TYPE		<table border="1"> <thead> <tr> <th>Input specification No.</th> <th>Sensor type</th> <th>Temperature range</th> </tr> </thead> <tbody> <tr> <td>0</td> <td>K</td> <td>-200.0 to 1200.0°C</td> </tr> <tr> <td>1</td> <td>J</td> <td>-200.0 to 800.0°C</td> </tr> <tr> <td>2</td> <td>E</td> <td>-150.0 to 600.0°C</td> </tr> <tr> <td>3</td> <td>T</td> <td>-200.0 to 400.0°C</td> </tr> <tr> <td>4</td> <td>B</td> <td>400.0 to 1800.0°C</td> </tr> <tr> <td>5</td> <td>R</td> <td>0.0 to 1750.0°C</td> </tr> <tr> <td>6</td> <td>S</td> <td>0.0 to 1750.0°C</td> </tr> </tbody> </table>	Input specification No.	Sensor type	Temperature range	0	K	-200.0 to 1200.0°C	1	J	-200.0 to 800.0°C	2	E	-150.0 to 600.0°C	3	T	-200.0 to 400.0°C	4	B	400.0 to 1800.0°C	5	R	0.0 to 1750.0°C	6
Input specification No.	Sensor type	Temperature range																								
0	K	-200.0 to 1200.0°C																								
1	J	-200.0 to 800.0°C																								
2	E	-150.0 to 600.0°C																								
3	T	-200.0 to 400.0°C																								
4	B	400.0 to 1800.0°C																								
5	R	0.0 to 1750.0°C																								
6	S	0.0 to 1750.0°C																								
<b>G6F-TC2A</b> 	O	NDR	BOOL	"1" when the function block is finished without error. "1" remains during the scan where the execution condition is being satisfied and it changes into "0" at the next scan.																						
		ERR	BOOL	Error information indication area - If error occurs during initialization function block execution "1" is outputted and the module enter into the stop state. "1" remains during the scan where the execution condition is being satisfied and it changes into "0" at the next scan.																						
		STAT	USINT	Error status indication area - Used to output the error No. when it occurs during reading function block execution. - For description of errors, refer to the Section 4.4																						
		ACT	BOOL [Array] *Note 1	Run channel status indication area - After the initialization function block is finished without error, "1" is output if the channel is in normal state. But "0" is output for the disabled channels.																						

**REMARK**  
 \*Note 1: The numbers of Array are 16 in G3F-TC4A, 4 in G4F-TC2A/G6F-TC2A.

4.3.2 Module Reading (G3F-TC4A : TCR4RD, G4F-TC2A : TCR2RD, G6F-TC2A : TCR62RD)

The module reading function block processes all channels of the thermocouple input module in batch. The enabled channel outputs the temperature conversion value to the output variable TEMP.

Function Block	I/O	Variable	Data Type	Description
<b>G3F-TC4A</b> 	I	REQ	BOOL	Function block execution request area - Used to request an execution of the reading function block - If the conditions connected with this area are established while the program is running and "0" changes into "1" (  ), the module initialization function block is executed.
		NET_NO	USINT	Location No. of the slot where the local communication module to which the function block will be sent is mounted. - Setting range: 0 ~ 7
		ST_NO	USINT	Station No. of the communication module mounted in the remote I/O station. - Setting range: 0 ~ 63
		BASE	USINT	Base module location No. - Used to write the base No. where the thermocouple input module is mounted. - Setting range: GM1 series(0-31), GM2 series(0-7), GM3/4 series(0-3) GM6 series(0-1)
		SLOT	USINT	Slot location No. - Used to write the slot No. where the thermocouple input module is mounted. - Setting range: 0-7
		CH	BOOL [Array]	Used channel enable/disable specification - Used to enable or disable a channel for run. - Specify "1" for enabling, and "0" for disabling
		TYPE	BOOL [Array]	"1" when the function block is finished without error. "1" remains during the scan where the execution condition is being satisfied and changes into "0" at next scan.
<b>G4F-TC2A</b> 	O	NDR	*Note 1 BOOL	"1" when the function block is finished without error. "1" remains during the scan where the execution condition is being satisfied and changes into "0" at next scan.
		ERR	BOOL	Error information indication area - If error occurs during initialization function block execution "1" is outputted and the module enter into the stop state. "1" remains during the scan where the execution condition is being satisfied and it changes into "0" at the next scan.
		STAT	USINT	Error status indication area - Used to output the error No. when it occurs during reading function block execution. - For description of errors, refer to Section 4.4
		ACT	BOOL [Array] *Note 1	Run channel status indication area - After the initialization function block is finished with no error, "1" is output if the channel is in normal state. But "0" is output for the disabled channels.
		ALM	BOOL [Array] *Note 1	Run channel error indication area - "1" is outputted when error occurs for each run channel.
		ALM_CODE	USINT [Array] *Note 1	Run channel error code area - Outputs the following code for each channel coded if error occurred. 0: Normal 16: Disconnection detected 17: Out-of-the-measuring-range error 18: Reference junction compensation device error
		TEMP	INT [Array] *Note 1	Temperature conversion value output area - The CPU module reads the temperature conversion value of the corresponding channel from the thermocouple-input module and outputs it to this area. - The temperature conversion value of each channel is 10 times than the real temperature value. - (Example: Temperature conversion value 1234 → Real temperature value 123.4°C)
<b>G6F-TC2A</b> 		SCAL	INT [Array] *Note 1	Digital conversion value output area - The CPU module reads the digital conversion value of the corresponding channel from the thermocouple-input module and outputs it to this area. - The temperature conversion value of each channel within its measuring temperature range is converted into a digital value within 0 to 16000 and it is outputted to this area. - The Value read from the output variable SCAL. 16000 ----- Overall measuring temperature range      ✖ (Temperature conversion value - Minimum measuring temperature)  - The output value through digital conversion can be used as a PV of the PID control module.

**REMARK**  
 \*Note 1: The numbers of Array are 16 in G3F-TC4A, 4 in G4F-TC2A/G6F-TC2A.

#### 4.4 Errors Indicated During Execution of Function Block

##### 4.4.1 Errors Indicated by the Output Variable, STAT

Errors indicated the output variable, STAT and their corrective actions are explained.

STAT No.	Item	Description	Function Block			Corrective Action	
			Initial-ization	Reading			
				Array	Stand alone		
0	Local	Normal run status	O	O	O	—	
1		Base location No. outside the setting range	O	O	O	Adjust it within the setting range	
2		The corresponding base unit hardware defect	O	O	O	Contact a service station	
3		Slot location No. outside the setting range	O	O	O	Specify correctly the slot No. where the PID control module is mounted.	
4		The specified slot has no thermocouple input module	O	O	O	Mount thermocouple input module on the specified slot.	
5		A module other than thermocouple input module is loaded on.	O	O	O	Mount thermocouple input module on the specified slot.	
6		Channel No. outside the setting range	—	—	O	Specify correctly the run channel.	
7		Thermocouple input module hardware defect	O	O	O	Contact a service station.	
8		Thermocouple input module memory defect	O	O	O	Contact a service station.	
9		The run channel was not specified in the Initialization function block.	—	O	O	Specify correctly run channels in the initialization function block.	
10		Disconnection detected at one or more of the use channels, or temperature outside the range.	—	O	—	See Section 9.2.4	
16		A disconnection of thermocouple or compensating wire was detected at the use channels	—	—	O	Fix the disconnection of the thermocouple or compensating wire.	
17		Out-of-the-range temperature was detected at the used channels	—	—	O	Check the specification of used thermocouple, and then use a temperature within the defined range.	
18		Reference junction compensation device connection defect	—	—	O	Check the connection of the reference junction compensation device.	
128		Remote	Remote communications module H/W defect	O	O	—	See Remote communications module User's Manual
129			Base location No. outside the setting range	O	O	—	Adjust it within the setting range
131			Slot location No. outside the setting range	O	O	—	Specify correctly the slot No. where thermocouple input module is mounted.
133			A module other than thermocouple input module is loaded on.	O	O	—	Mount thermocouple input module on the specified slot.
135	Thermocouple input module hardware defect		O	O	—	Contact a service station.	
136	Thermocouple input module memory defect		O	O	—	Contact a service station.	
137	The run channel was not specified in the initialization function block.		—	O	—	Specify correctly run channels in the initialization function block.	
138	Disconnection detected at one or more of the use channels, or temperature outside the range.		—	O	—	See the Section 9.2.4	

##### 4.4.2 Errors indicated by the output variable, ALM\_CODE in the array type temperature conversion value reading function block.

(G3F-TC4A : TC4ARD, TCR4RD. G4F-TC2A : TC2ARD, TCR2RD G6F-TC2A : TC2ARD, TCR62RD)

ALM_CODE No.	Description	Corrective Action
0	Normal run status	—
16	Disconnection of the thermocouple or compensating wire	Fix the disconnection between the thermocouple input module and the thermocouple
17	Out-of-the range temperature	Specify correctly the type of the thermocouple or use the temperature within defined range.
18	Reference junction compensation device connection defect	Check the connection of the reference junction compensation device.

## Chapter 5. PROGRAMMING

### 5.1 A program for Converting a Detected Temperature Value(° C) into Fahrenheit(° F) and Outputting as a BCD Value

#### 1) System Configuration

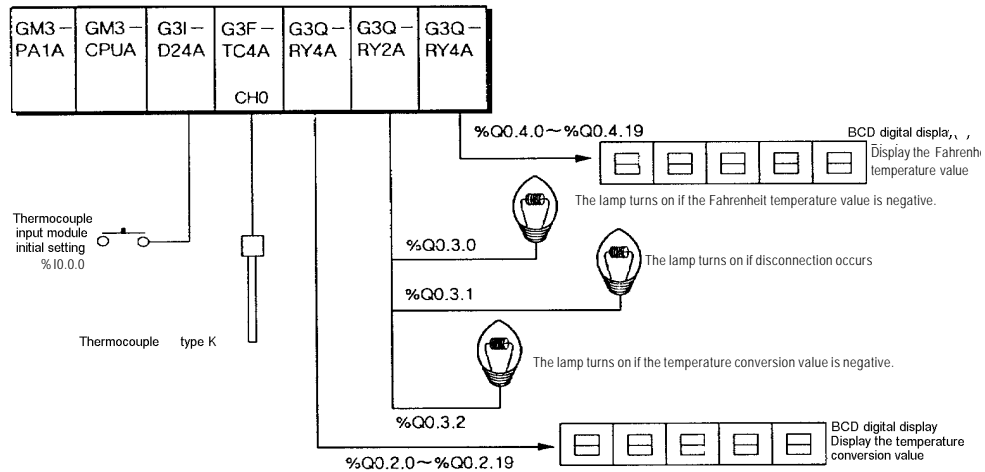

#### 2) Initial settings

- (1) Specifying the used channel: channel 0
- (2) Specifying the type of the thermocouple : Type K

#### 3) Expression for conversion of a temperature conversion value into a Fahrenheit temperature(° F)

$$\begin{aligned}
 \text{Temperature conversion value} &= \text{Detected temperature value} \times 10 \\
 \text{Fahrenheit temperature(°F)} &= \text{Detected temperature value} \times 1.8 + 32 \\
 &= \frac{\text{Temperature conversion value}}{10} \times 1.8 + 32 \\
 &= \frac{\text{Temperature conversion value} \times 18 + 320}{10}
 \end{aligned}$$

∴ If the Fahrenheit temperature displayed on the BCD digital display is displayed with the value of 'detected Fahrenheit temperature (°F) × 10', then it is needed to process the expression "temperature conversion value × 18 + 320".

#### 4) Program Description

- (1) If %I0.0.0 turns on then the thermocouple input module would be initialized.
- (2) The temperature conversion value is displayed on the BCD digital display of %Q0.2.0 to %Q0.2.19. If the value is negative the ramp %Q0.3.2 will turn on.
- (3) After the conversion of the temperature conversion value into a Fahrenheit temperature (°F), it will be displayed on the BCD digital display of %Q0.4.0 to %Q0.4.19. If it is negative the ramp %Q0.3.0 will turn on.
- (4) If disconnection is detected during conversion of temperature of the channel 0, the ramp %Q0.3.1 will turn on.

5) Program

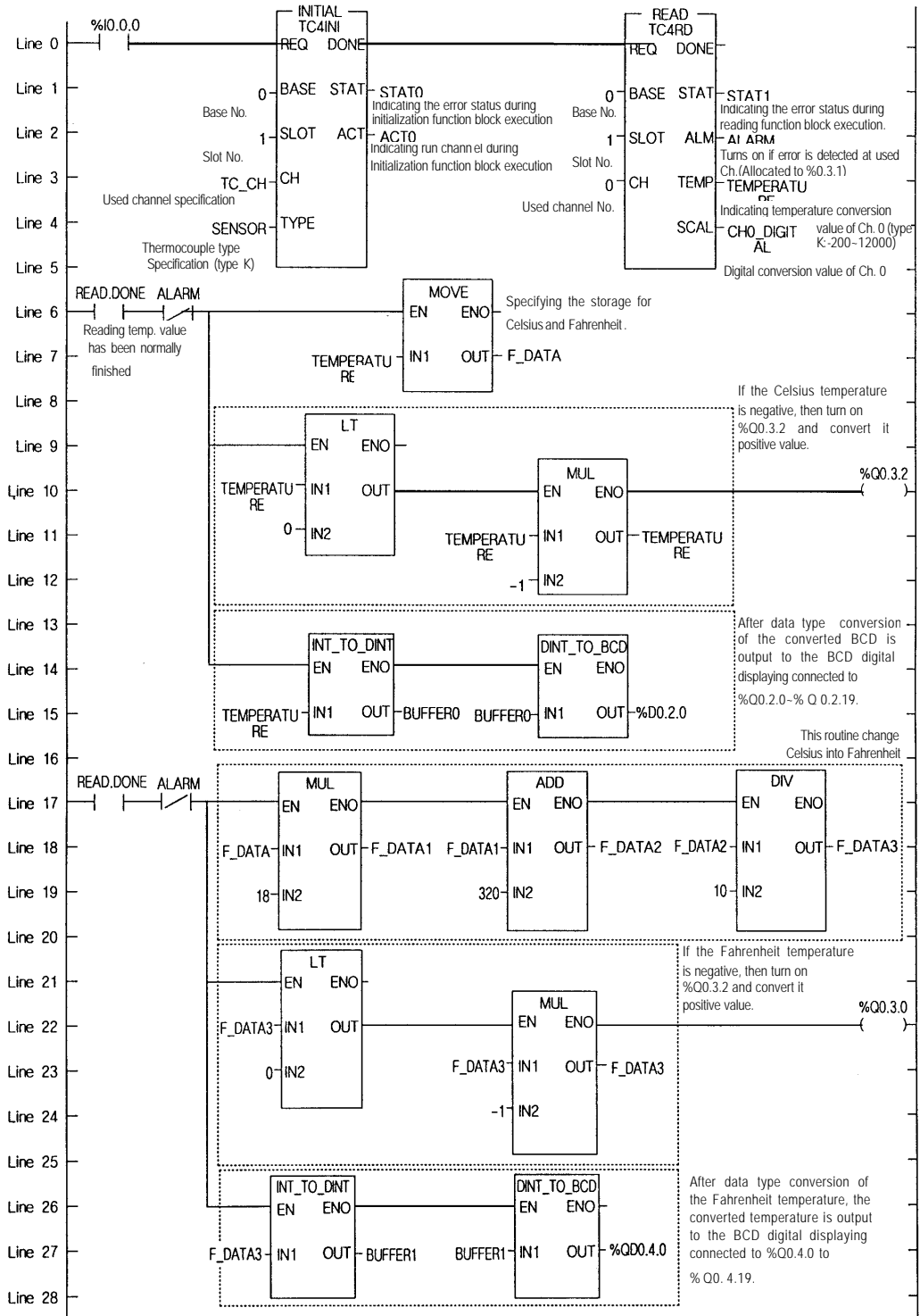

6) Initial Value Setting Method for I/O Variables

(1) Channel Specification

The image shows three overlapping dialog boxes used for setting initial values for I/O variables.

**Add/Edit Variables Dialog:**

- Variable Name: TC\_CH
- Variable Kind: VAR
- Data Type:
  - Elementary: BOOL
  - FB Instance: AD4ARD
  - Array: (0..15) OF BOOL
- Memory Allocation: Auto
- Buttons: OK, Cancel, Help, Init. Array...

**Initialize Array Dialog:**

- Array Name: TC\_CH : ARRAY [0..15] OF BOOL
- Options: No Init, Initialize
- Buttons: Close, Help, Edit...

**Initialize Array Element Dialog:**

- Array Element Name: TC\_CH[0]
- Initial Value: 0
- Buttons: OK, Cancel, Help, Prev Item, Next Item

**Annotations:**

- "This denotes 16 channels" points to the "Array (0..15) OF" field in the first dialog.
- "Select this and this screen appears" points to the "Init. Array..." button in the first dialog.
- "Channel No." points to the list of indices [0] through [15] in the second dialog.
- "Channel enable : 1" and "Channel disable : 0" point to the values 1 and 0 in the second dialog's list.
- "Select this and this screen appears" points to the "Edit..." button in the second dialog.
- "Selection of the previous channel" points to the "Prev Item" button in the third dialog.
- "Selection of the next channel" points to the "Next Item" button in the third dialog.
- "Channel enable/disable specification" points to the "Initial Value" field in the third dialog.

(2) Thermocouple Type Specification

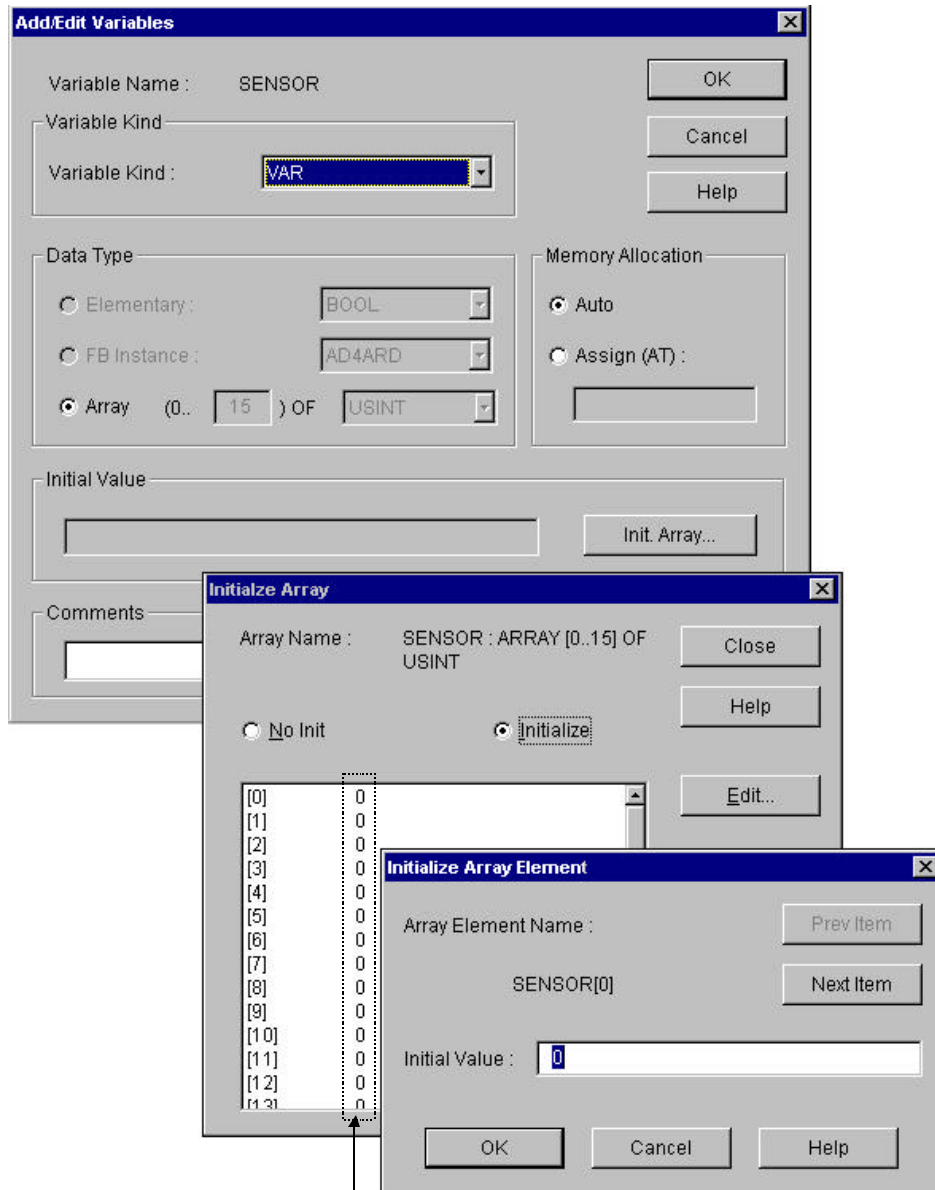

Thermocouple type specification

Input specification No.	Sensor type	Temperature range
0	K	-200.0 to 1200.0°C
1	J	-200.0 to 800.0°C
2	E	-150.0 to 600.0°C
3	T	-200.0 to 400.0°C
4	B	400.0 to 1800.0°C
5	R	0.0 to 1750.0°C
6	S	0.0 to 1750.0°C

7) I/O Variables Used in the Program

Variable Name	Var_Kind	Data Type	(AT Address)	(Initial Value)
ACT0	: VAR	: ARRAY [0..15] OF BOOL		
ALARM	: VAR	: BOOL	AT %Q0.3.1	
BUFFER0	: VAR	: DINT		
BUFFER1	: VAR	: DINT		
CHO_DIGITAL	: VAR	: INT		
F_DATA	: VAR	: INT		
F_DATA1	: VAR	: INT		
F_DATA2	: VAR	: INT		
F_DATA3	: VAR	: INT		
INITIAL	: VAR	: FB Instance		: = { 0, 0, 0, 0, 0, 0, 0, 0, 0, 0, 0, 0, 0, 0, 0 }
READ	: VAR	: FB Instance		
SENSOR	: VAR	: ARRAY [0..15] OF USINT		
STAT0	: VAR	: USINT		
STAT1	: VAR	: USINT		
TC_CH	: VAR	: ARRAY [0..15] OF BOOL		: = { 1, 0, 0, 0, 0, 0, 0, 0, 0, 0, 0, 0, 0, 0, 0 }
TC_INI	: VAR	: FB Instance		
TEMPERATURE	: VAR	: INT		

## 5.2 A program for Magnitude Comparison of a Detected Temperature Value

### 1) System Configuration

GM3 – PA1A	GM3 – CPUA	G3F – TC4A	G3Q – RY2A		
---------------	---------------	---------------	---------------	--	--

### 2) Initial Settings

- (1) Used Channel : Channel 0 and 1
- (2) Thermocouple type specification : Type K

### 3) Program Descriptions

- (1) If the temperature that is input through the channel 0 of the thermocouple input module is less than  $-20^{\circ}\text{C}$  or larger than  $-30^{\circ}\text{C}$ , %Q0.1.0 turns on.
- (2) If the temperature that is input through the channel 1 of the thermocouple input module is less than  $-20^{\circ}\text{C}$  or larger than  $-30^{\circ}\text{C}$ , %Q0.1.1 turns on.
- (3) If the difference between the two temperatures that are input through the channel 0 and 1 is larger than  $5^{\circ}\text{C}$ , %Q0.1.2 turns on.

4) Program

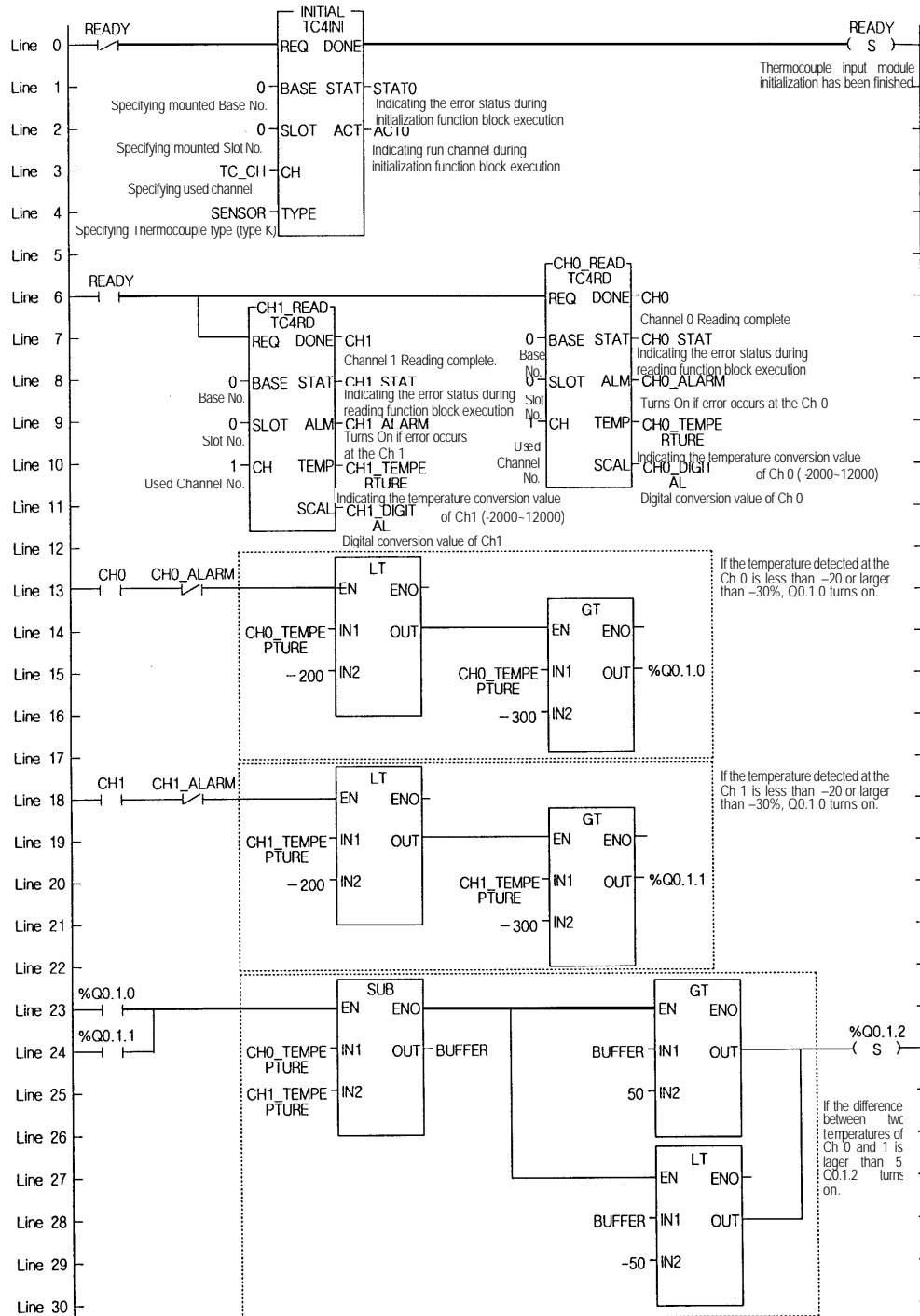

5) I/O Variables Used in the Program

Variable Name	Var_Kind	Data Type	(AT Address)	(Initial Value)
ACT0	: VAR	: ARRAY [0..15] OF BOOL		
BUFFER	: VAR	: INT		
CH0	: VAR	: BOOL		
CH0_ALARM	: VAR	: BOOL		
CH0_DIGITAL	: VAR	: INT		
CH0_READ	: VAR	: FB Instance		
CH0_STAT	: VAR	: USINT		
CH0_TEMPERATURE	: VAR	: INT		
CH1	: VAR	: BOOL		
CH1_ALARM	: VAR	: BOOL		
CH1_DIGITAL	: VAR	: INT		
CH1_READ	: VAR	: FB Instance		
CH1_STAT	: VAR	: USINT		
CH1_TEMPERATURE	: VAR	: INT		
INITIAL	: VAR	: FB Instance		
READY	: VAR	: BOOL		
SENSOR	: VAR	: ARRAY [0..15] OF USINT		:= { 0, 0, 0, 0, 0, 0, 0, 0, 0, 0, 0, 0, 0, 0, 0 }
STAT0	: VAR	: USINT		
TC_CH	: VAR	: ARRAY [0..15] OF BOOL		:= { 1, 1, 0, 0, 0, 0, 0, 0, 0, 0, 0, 0, 0, 0, 0 }

### 5.3 A Program Used When Mounting a Thermocouple Input Module onto the Remote I/O Station

#### 1) System Configuration

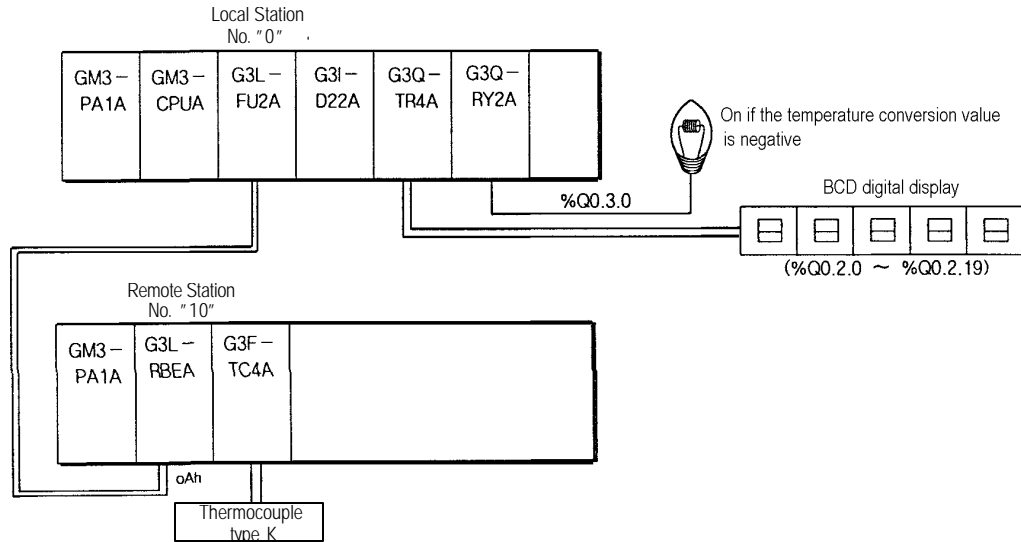

#### 2) Initial Settings

- (1) Specifying used channel : Channel 0
- (2) Specifying thermocouple type: Type K

#### 3) Program Description

- (1) `_NET0_LIV[10]` : Turns "On" if the local normally communicates with the remote.
- `_NET0_RST[10]` : Turns "On" if communications error or power failure occurs. The user has to turn it off forcibly when the normal state has been restored.
- (2) If the temperature conversion value is negative, %Q0.3.0 will be turned "On" and the value will be changed into a positive value.
- (3) If no error has been occurred during execution of the reading function block, the temperature conversion value will be output to "%Q0.2.0".

4) Program

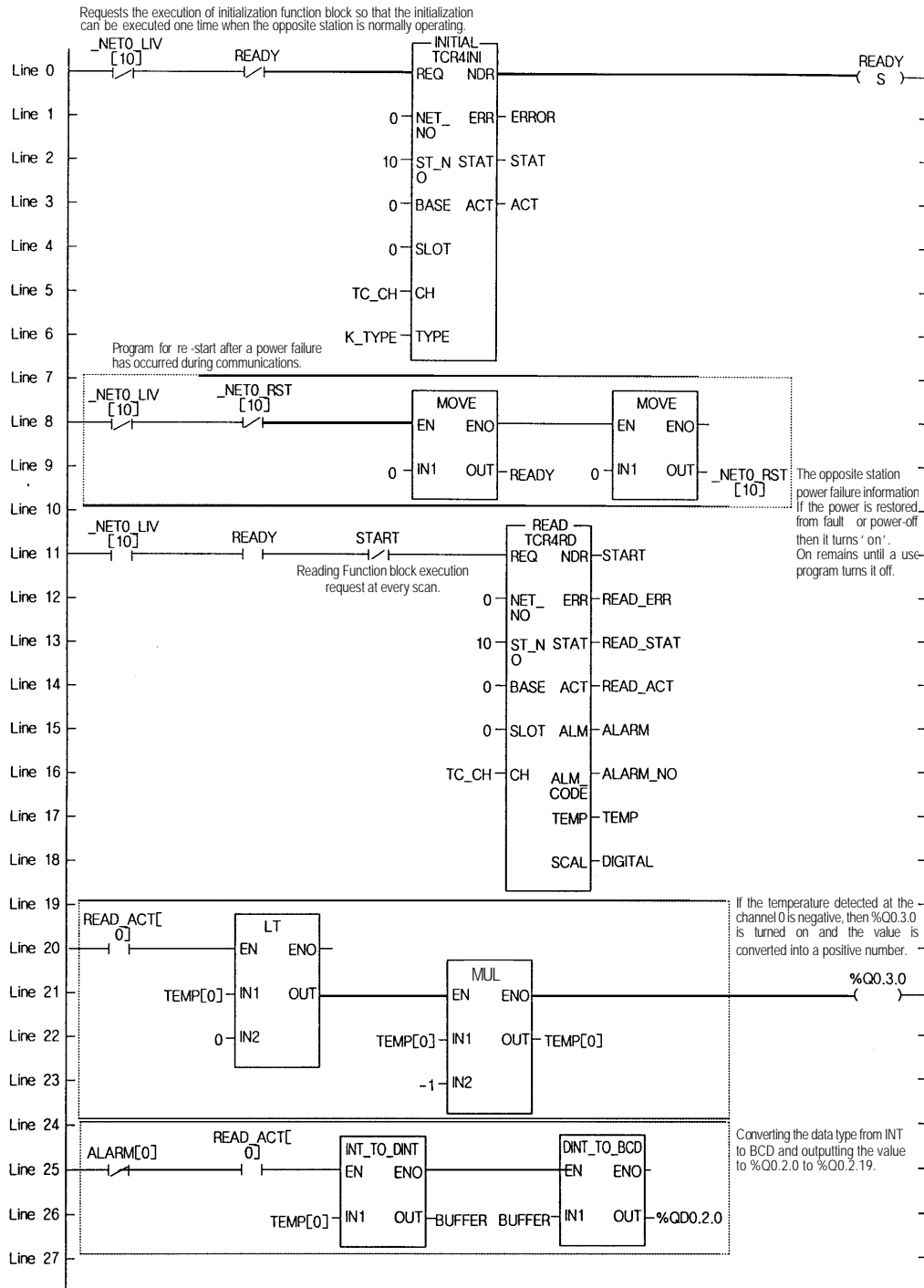

5) I/O Variables Used in the Program

Variable Name	Var_Kind	Data Type	(AT Address)	(Initial Value)
ACT0	: VAR	: ARRAY [0..15] OF BOOL		
BUFFER	: VAR	: INT		
CH0	: VAR	: BOOL		
CH0_ALARM	: VAR	: BOOL		
CH0_DIGITAL	: VAR	: INT		
CH0_READ	: VAR	: FB Instance		
CH0_STAT	: VAR	: USINT		
CH0_TEMPERATURE	: VAR	: INT		
CH1	: VAR	: BOOL		
CH1_ALARM	: VAR	: BOOL		
CH1_DIGITAL	: VAR	: INT		
CH1_READ	: VAR	: FB Instance		
CH1_STAT	: VAR	: USINT		
CH1_TEMPERATURE	: VAR	: INT		
INITIAL	: VAR	: FB Instance		
READY	: VAR	: BOOL		
SENSOR	: VAR	: ARRAY [0..15] OF USINT	:= { 0,0,0,0,0,0,0,0,0,0,0,0,0,0,0,0 }	
STAT0	: VAR	: USINT		
TC_CH	: VAR	: ARRAY [0..15] OF BOOL	:= { 1,0,0,0,0,0,0,0,0,0,0,0,0,0,0,0 }	

## Chapter 6. BUFFER MEMORY CONFIGURATION AND FUNCTIONS

The thermocouple-input module has the PLC CPU and the buffer memories for data communications.

### 6.1 Buffer Memory Configuration

The followings describe buffer memory configuration.

#### 6.1.1 G3F-TC4A Buffer Memory

Address (Decimal)	Function	Description	Default Setting	Read / Write																								
0	Channel enable/disable Specification	Bit On(1): Enable, Bit Off(0) : Disable	Disable	R/W																								
1	Specifying the type of thermocouple for channel 0	<table border="1"> <thead> <tr> <th>Input specification No.</th> <th>Sensor type</th> <th>Temperature range</th> </tr> </thead> <tbody> <tr> <td>0</td> <td>K</td> <td>-200.0 to 1200.0 °C</td> </tr> <tr> <td>1</td> <td>J</td> <td>-200.0 to 800.0 °C</td> </tr> <tr> <td>2</td> <td>E</td> <td>-150.0 to 600.0 °C</td> </tr> <tr> <td>3</td> <td>T</td> <td>-200.0 to 400.0 °C</td> </tr> <tr> <td>4</td> <td>B</td> <td>400.0 to 1800.0 °C</td> </tr> <tr> <td>5</td> <td>R</td> <td>0.0 to 1750.0 °C</td> </tr> <tr> <td>6</td> <td>S</td> <td>0.0 to 1750.0 °C</td> </tr> </tbody> </table> <p>If a value outside the defined range is set, the bit of address 67 that corresponds to the channel turns on and the thermocouple type will be set to type K.</p>	Input specification No.	Sensor type	Temperature range	0	K	-200.0 to 1200.0 °C	1	J	-200.0 to 800.0 °C	2	E	-150.0 to 600.0 °C	3	T	-200.0 to 400.0 °C	4	B	400.0 to 1800.0 °C	5	R	0.0 to 1750.0 °C	6	S	0.0 to 1750.0 °C	Type K	R/W
Input specification No.	Sensor type		Temperature range																									
0	K		-200.0 to 1200.0 °C																									
1	J		-200.0 to 800.0 °C																									
2	E		-150.0 to 600.0 °C																									
3	T		-200.0 to 400.0 °C																									
4	B		400.0 to 1800.0 °C																									
5	R		0.0 to 1750.0 °C																									
6	S		0.0 to 1750.0 °C																									
2	Specifying the type of thermocouple for channel 1																											
3	Specifying the type of thermocouple for channel 2																											
4	Specifying the type of thermocouple for channel 3																											
5	Specifying the type of thermocouple for channel 4																											
6	Specifying the type of thermocouple for channel 5																											
7	Specifying the type of thermocouple for channel 6																											
8	Specifying the type of thermocouple for channel 7																											
9	Specifying the type of thermocouple for channel 8																											
10	Specifying the type of thermocouple for channel 9																											
11	Specifying the type of thermocouple for channel 10																											
12	Specifying the type of thermocouple for channel 11																											
13	Specifying the type of thermocouple for channel 12																											
14	Specifying the type of thermocouple for channel 13																											
15	Specifying the type of thermocouple for channel 14																											
16	Specifying the type of thermocouple for channel 15																											
17	Temperature conversion value of the channel 0	<ul style="list-style-type: none"> <li>Temperature conversion value : 10 times of a real temperature is displayed.</li> <li>Digital conversion value If a temperature conversion value is converted into a value within 0 to 16000, that value is a digital conversion value. It can be used as a process value of the PID control module. Expression Digital conversion value = (16000 / measuring temperature range) × (temperature conversion value – minimum measuring temperature)</li> <li>Error code 16 : Disconnection detection error 17 : Upper or lower overflow 18 : Reference junction compensation device error</li> </ul>	—	Read Only																								
18	Digital conversion value of the channel 0																											
19	Error code of the channel 0																											
20	Temperature conversion value of the channel 1																											
21	Digital conversion value of the channel 1																											
22	Error code of the channel 1																											
23	Temperature conversion value of the channel 2																											
24	Digital conversion value of the channel 2																											
25	Error code of the channel 2																											
26	Temperature conversion value of the channel 3																											
27	Digital conversion value of the channel 3																											
28	Error code of the channel 3																											
29	Temperature conversion value of the channel 4																											
30	Digital conversion value of the channel 4																											
31	Error code of the channel 4																											

Address (Decimal)	Function	Description	Default Setting	Read / Write
32	Temperature conversion value of the channel 5	<ul style="list-style-type: none"> <li>• Temperature conversion value : 10 times of a real temperature is displayed.</li> <li>• Digital conversion value If a temperature conversion value is converted into a value within 0 to 16000, that value is a digital conversion value. It can be used as a process value of the PID control module. Expression Digital conversion value = (16000/measuring temperature range) × (temperature conversion value – minimum measuring temperature)</li> <li>• Error code 16 : Disconnection detection error 17 : Upper or lower overflow 18 : Reference junction compensation device error</li> </ul>	—	Read Only
33	Digital conversion value of the channel 5			
34	Error code of the channel 5			
35	Temperature conversion value of the channel 6			
36	Digital conversion value of the channel 6			
37	Error code of the channel 6			
38	Temperature conversion value of the channel 7			
39	Digital conversion value of the channel 7			
40	Error code of the channel 7			
41	Temperature conversion value of the channel 8			
42	Digital conversion value of the channel 8			
43	Error code of the channel 8			
44	Temperature conversion value of the channel 9			
45	Digital conversion value of the channel 9			
46	Error code of the channel 9			
47	Temperature conversion value of the channel 10			
48	Digital conversion value of the channel 10			
49	Error code of the channel 10			
50	Temperature conversion value of the channel 11			
51	Digital conversion value of the channel 11			
52	Error code of the channel 11			
53	Temperature conversion value of the channel 12			
54	Digital conversion value of the channel 12			
55	Error code of the channel 12			
56	Temperature conversion value of the channel 13			
57	Digital conversion value of the channel 13			
58	Error code of the channel 13			
59	Temperature conversion value of the channel 14			
60	Digital conversion value of the channel 14			
61	Error code of the channel 14			
62	Temperature conversion value of the channel 15			
63	Digital conversion value of the channel 15			
64	Error code of the channel 15			
65	SET data	Bit On(1) : New setting values are set for the contents of address 0 to 16. Bit Off(0) : The existing values of address 0 to 16 remains.	No setting	R/W
66	Run channel information	Bit On(1) : Running, Bit Off(0) : Stop	—	Read only
67	Setting Error information	Bit On(1) : if other value than 0 to 6 is set for specifying the type of thermocouples in the address 1 to 16. Bit Off(0) : If 0 to 6 is set for specifying the type of thermocouples in the address 1 to 16.	—	Read only

6.1.2 G4F-TC2A / G6F-TC2A Buffer Memory

Address (Decimal)	Function	Description	Default Setting	Read / Write																								
0	Channel enable/disable Specification	Bit On(1): Enable, Bit Off(0) : Disable	Disable	R/W																								
1	Specifying the type of thermocouple for channel 0	<table border="1"> <thead> <tr> <th>Input specification No.</th> <th>Sensor type</th> <th>Temperature range</th> </tr> </thead> <tbody> <tr> <td>0</td> <td>K</td> <td>-200.0 to 1200.0 °C</td> </tr> <tr> <td>1</td> <td>J</td> <td>-200.0 to 800.0 °C</td> </tr> <tr> <td>2</td> <td>E</td> <td>-150.0 to 600.0 °C</td> </tr> <tr> <td>3</td> <td>T</td> <td>-200.0 to 400.0 °C</td> </tr> <tr> <td>4</td> <td>B</td> <td>400.0 to 1800.0 °C</td> </tr> <tr> <td>5</td> <td>R</td> <td>0.0 to 1750.0 °C</td> </tr> <tr> <td>6</td> <td>S</td> <td>0.0 to 1750.0 °C</td> </tr> </tbody> </table> <p>If a value outside the defined range is set, the bit of address 19 that corresponds to the channel turns on and the thermocouple type will be set to type K.</p>	Input specification No.	Sensor type	Temperature range	0	K	-200.0 to 1200.0 °C	1	J	-200.0 to 800.0 °C	2	E	-150.0 to 600.0 °C	3	T	-200.0 to 400.0 °C	4	B	400.0 to 1800.0 °C	5	R	0.0 to 1750.0 °C	6	S	0.0 to 1750.0 °C	Type K	R/W
Input specification No.	Sensor type		Temperature range																									
0	K		-200.0 to 1200.0 °C																									
1	J		-200.0 to 800.0 °C																									
2	E		-150.0 to 600.0 °C																									
3	T	-200.0 to 400.0 °C																										
4	B	400.0 to 1800.0 °C																										
5	R	0.0 to 1750.0 °C																										
6	S	0.0 to 1750.0 °C																										
2	Specifying the type of thermocouple for channel 1																											
3	Specifying the type of thermocouple for channel 2																											
4	Specifying the type of thermocouple for channel 3																											
5	Temperature conversion value of the channel 0	<ul style="list-style-type: none"> <li>Temperature conversion value : 10 times of a real temperature is displayed.</li> <li>Digital conversion value</li> </ul> <p>If a temperature conversion value is converted into a value within 0 to 16000, that value is a digital conversion value. It can be used as a process value of the PID control module.</p> <p>Expression  <math display="block">\text{Digital conversion value} = (16000 / \text{measuring temperature range}) \times (\text{temperature conversion value} - \text{minimum measuring temperature})</math></p> <ul style="list-style-type: none"> <li>Error code</li> </ul> <p>16 : Disconnection detection error                      17 : Upper or lower overflow                      18 : Reference junction compensation device error</p>	—	Read Only																								
6	Digital conversion value of the channel 0																											
7	Error code of the channel 0																											
8	Temperature conversion value of the channel 1																											
9	Digital conversion value of the channel 1																											
10	Error code of the channel 1																											
11	Temperature conversion value of the channel 2																											
12	Digital conversion value of the channel 2																											
13	Error code of the channel 2																											
14	Temperature conversion value of the channel 3																											
15	Digital conversion value of the channel 3																											
16	Error code of the channel 3																											
17	SET data	Bit On(1) : New setting values are set for the contents of address 0 to 4. Bit Off(0) : The existing values of address 0 to 4 remains.	No setting	R/W																								
18	Run channel information	Bit On(1) : Running, Bit Off(0) : Stop	—	Read only																								
19	Setting error information	Bit On(1) : if other value than 0 to 6 is set for specifying the type of thermocouples in the address 1 to 4. Bit Off(0) : If 0 to 6 is set for specifying the type of thermocouples in the address 1 to 4.	—	Read only																								

## 6.2 Buffer Memory Functions

- ▶ Each address in the buffer memory occupies one word and it is represented with 16 bits.
- ▶ In the 16 bits which compose an address, every bit can be set to either "1" when it should be turned On or "0" when Off in order to implement the function of each bit.

### 6.2.1 Specifying Channel Enable/Disable

(G3F-TC4A : Address 0, G4F-TC2A / G6F-TC2A : Address 0)

- 1) Temperature conversion enable/disable specification is possible on every channel.
- 2) Disabling unused channels makes the sampling cycle short.
- 3) No specification means that all channels are disabled.
- 4) The followings show temperature conversion enable/disable for each channel.

#### (1) G3F-TC4A

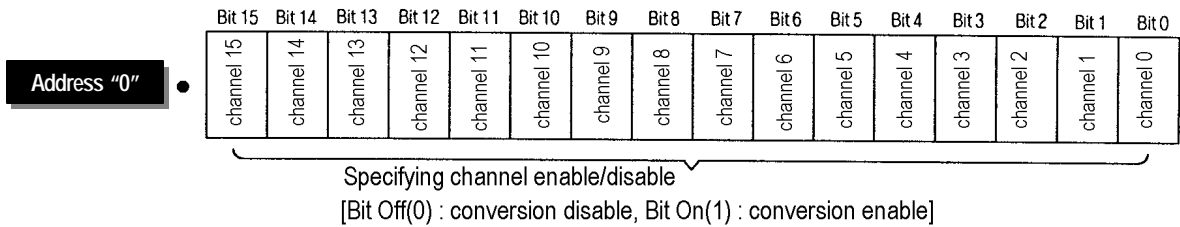

#### (2) G4F-TC2A/G6F-TC2A

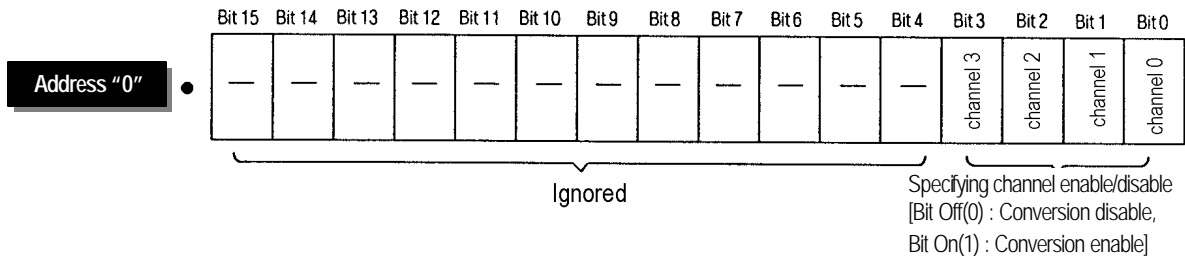

### 6.2.2 Specifying the Type of Thermocouple

(G3F-TC4A : Address 2 to 16, G4F-TC2A/G6F-TC2A : Address 1 to 4)

- 1) Type specifying the thermocouple that is connected to each channel of the thermocouple input module is possible by the channel.
- 2) Default is type K.
- 3) The followings show the number of specification for each channel.

Specification No.	0	1	2	3	4	5	6
Thermocouple type	K	J	E	T	B	R	S

- 4) Other value than the defined values is set for specifying the type of a thermocouple, the G3F-TC4A displays error code at the corresponding bit in the address 67 and the G4F-TC2A/G6F-TC2A in the address 19 with the type being specified to "0", that is, type K thermocouple.

6.2.3 Temperature Conversion Value

- 1) This area performs sampling processing of the temperature value that is inputted through the thermocouple connected to the terminal block of a channel and stores the value of 10 times of the real temperature value.

**REMARK**  
If a real temperature is 123.4°C the stored value is 1234.

- 2) The followings show the configuration of each address.

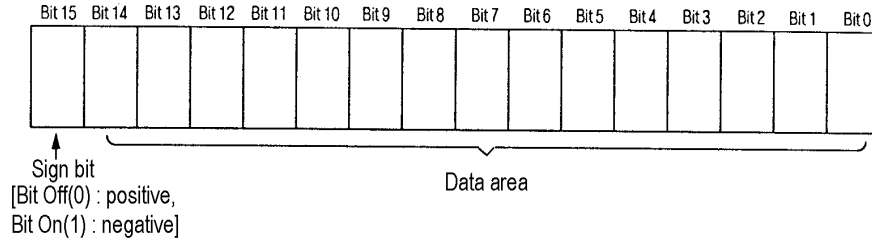

- 3) If the temperature conversion specifying a channel is changed from temperature conversion enable into temperature conversion disable, the temperature conversion value just before the change remains.

6.2.4 Digital Conversion Value

- 1) A temperature value that is inputted through the thermocouple connected to the terminal block of a channel is converted into a value between 0 to 16000, and then the converted value is stored. That conversion is called digital conversion.
- 2) The digital conversion value converted to a value between 0 to 16000 can be used as a process value of the PID control module.
- 3) The digital conversion value and the detected temperature value have the following arithmetic relation.

$$\text{Digital conversion value} = (16000/\text{overall measuring temperature range}) \times (\text{temperature conversion value} - \text{minimum measuring temperature})$$

**REMARK**  
If a real temperature is 123.4°C when using a type K thermocouple, since the temperature conversion value is 1234, overall temperature range is 14000 and minimum measuring temperature is -2000, then the digital conversion value is  $(16000/14000) \times [1234 - (-2000)]$ , and it is equal to 3696 (round off at the first digit of fraction).

Thermocouple type	K	J	E	T	B	R	S
overall measuring temperature range	14000 (-2000 to 12000)	10000 (-2000 to 8000)	7500 (-1500 to 6000)	6000 (-2000 to 4000)	14000 (4000 to 18000)	17500 (0 to 17500)	17500 (0 to 17500)
Minimum measuring temperature	-2000	-2000	-1500	-2000	4000	0	0

- 4) If the temperature conversion specifying a channel is changed from enable into disable, the digital conversion value before the change remains

6.2.5 Error Code

- 1) Disconnection that can occur between the thermocouple and the thermocouple input module is detected by its type, and also error information is stored when the detected temperature is outside the defined range.
- 2) The following shows the types of error code.

Error Code (Decimal)	Error	Data processing at an error occurrence	RUN LED
16	Disconnection	The temperature conversion value and digital conversion value before an error occurrence is retained.	1 sec cycle flickering
17	Out-of-range temperature		
18	Reference junction compensation device error		

- 3) If two or more errors are detected, the priority order is 18, then 17 and then 16.

6.2.6 Setting SET Data (G3F-TC4A : Address 65, G4F-TC2A/G6F-TC2A: Address 17)

- 1) If a bit corresponding to each channel in Set Data specification area is turned On(1), then the thermocouple input module executes the temperature conversion with user-defined setting data at the address 0 to 16 in the G3F-TC4A, and at the address 0 to 4 in the G4F-TC2A.
- 2) If the bit corresponding to each channel is not turned On(1), then the thermocouple input module executes the temperature conversion not with the new user-defined setting data at the address 0 to 16 in the G3F-TC4A and at the address 0 to 4 in the G4F-TC2A but with the previous setting data.
- 3) If a bit0 corresponding to all channel in set data specification area is turned on(1),then the thermocouple input module executes the temperature conversion with user-defined setting data at address 0 to 4 in the G6F-TC2A
- 4) The followings show the SET data enable/disable specification

(1) G3F-TC4A

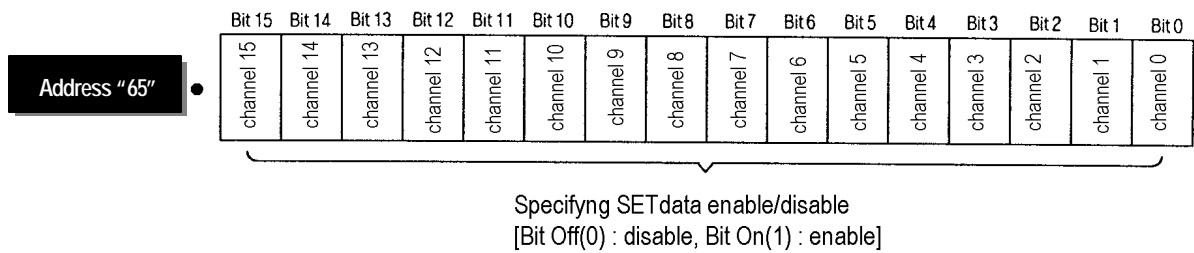

(2) G4F-TC2A

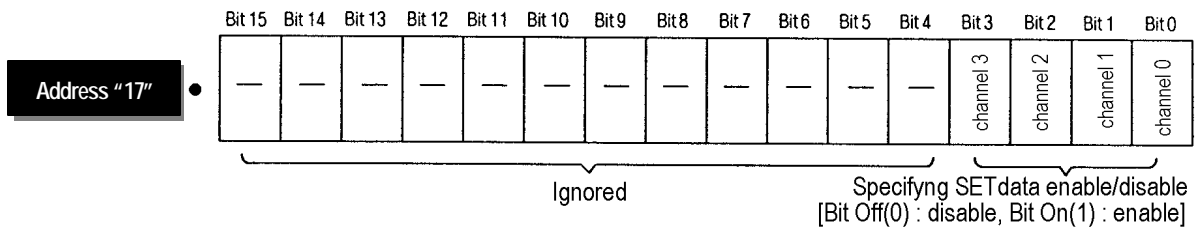

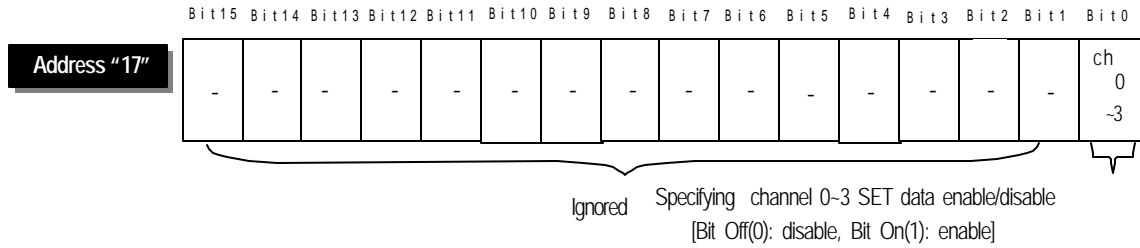

6.2.7 Information on Run Channel (G3F-TC4A : Address 66, G4F-TC2A/G6F-TC2A : Address 18)

This area stores information on run status of each channel.

(1) G3F-TC4A

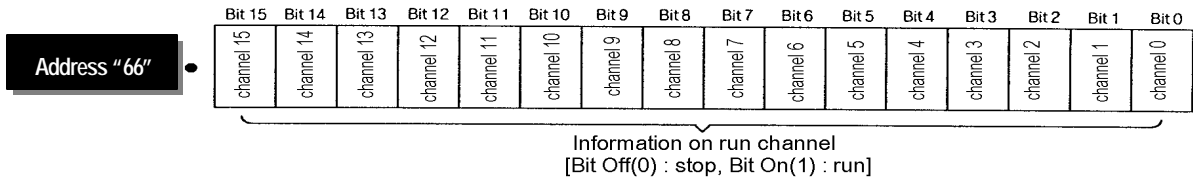

(2) G4F-TC2A/G6F-TC2A

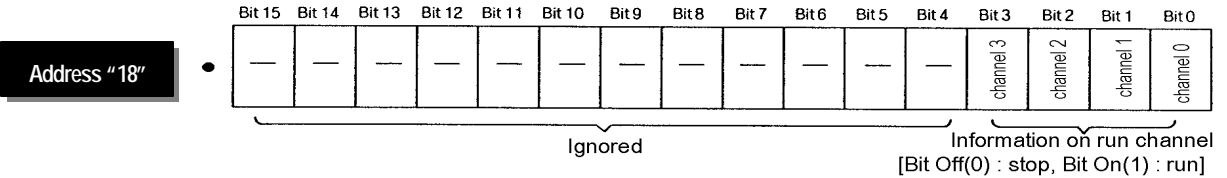

6.2.8 Information on Thermocouple Type Specification Error

(G3F-TC4A : Address 67, G4F-TC2A/G6F-TC2A : Address 19)

- 1) If other value than "0" to "6" is set at the addresses (Address 1 to 16 in G3F-TC4A, Address 1 to 4 in G4F-TC2A/G6F-TC2A) used for specifying the type of the thermocouple which is connected to each channel of the thermocouple input module, error occurs.
- 2) If error occurs at a channel, then the channel runs with the type K as the type of the thermocouple.
- 3) The following shows indication of error information.

(1) G3F-TC4A

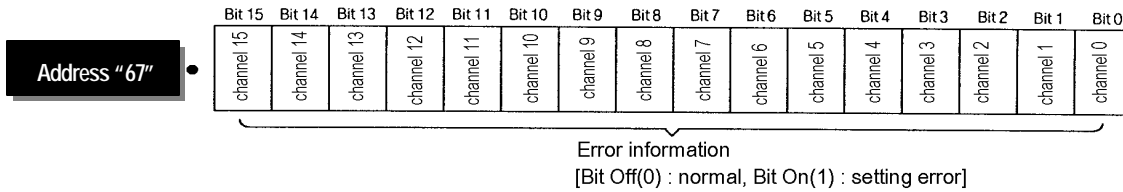

(2) G4F-TC2A/G6F-TC2A

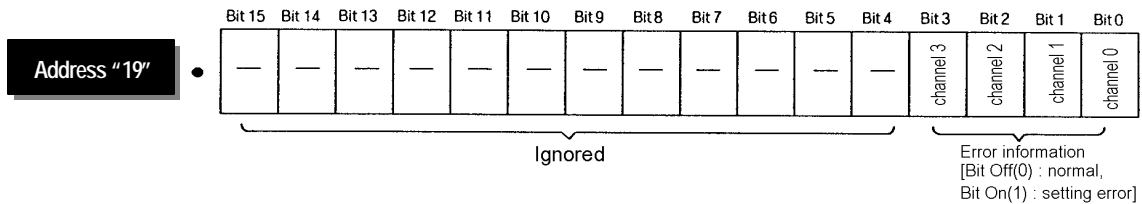

## Chapter 7. DEDICATED INSTRUCTIONS FOR SPECIAL MODULES (Read from /Write to Buffer Memory)

The thermocouple input module occupies 16 I/O points.

### 7.1 Local

#### 7.1.1 Read from Buffer Memory ×××GET, GETP

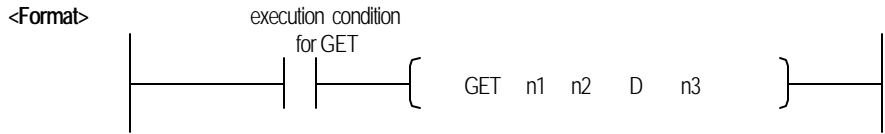

Format	Description	Available Data Type
n1	The slot No. where the specific modules mounted	Integer
n2	Head address of the specific module buffer memory from which the data will be read.	Integer
D	Head address of the device to store the data read.	M,P,K,J,T,C,D,#D
n3	Word number of data to be read.	Integer

<The difference between GET and GETP>

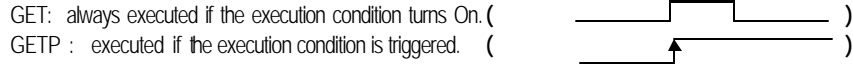

Example 1). In this example, the thermocouple input module is mounted on the slot 3 in the unit and the data of buffer memory addresses 17, 18 and 19 will be read to the CPU module addresses D17, D18 and D19.

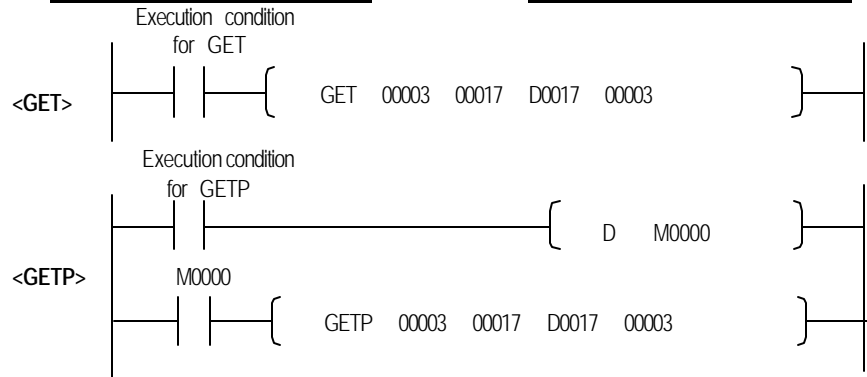
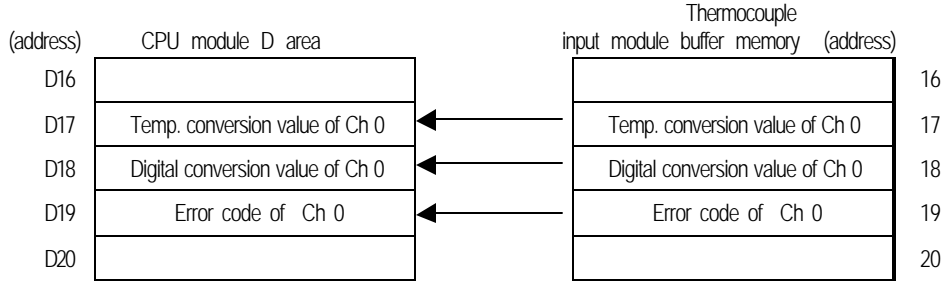

7.1.2 Write to Buffer Memory xxx PUT, PUTP

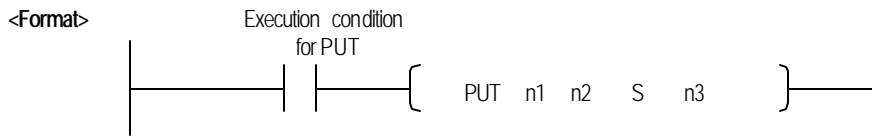

Format	Description	Available Data Type
n1	The slot No. where the specific modules mounted	Integer
n2	Head address of the specific module buffer memory to which the data will be written..	Integer
S	Head address of the device where the data to be written has been stored, or an integer	M,P,K,L,T,C,D,#D
n3	Word number of data to be written.	Integer

<The difference between PUT and PUTP>

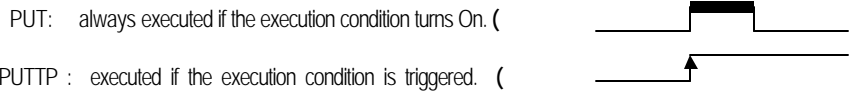

Example 1) In this example, the thermocouple input module is mounted on the slot 6 in the unit and the data of CPU module addresses D50 and D51 will be written to the buffer memory addresses 3 and 4.

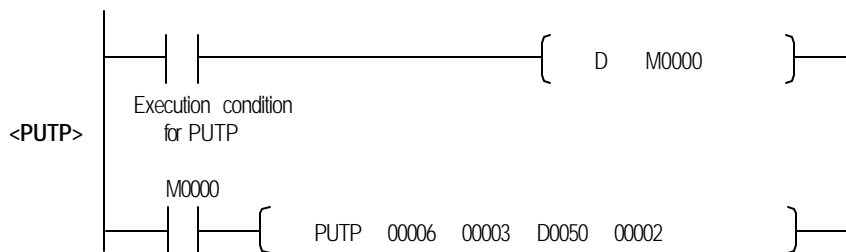
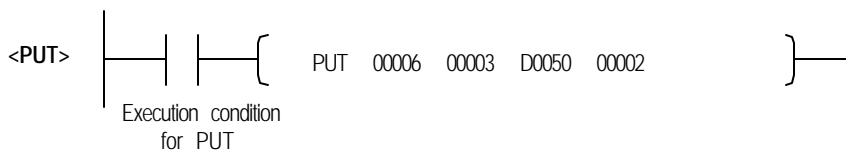
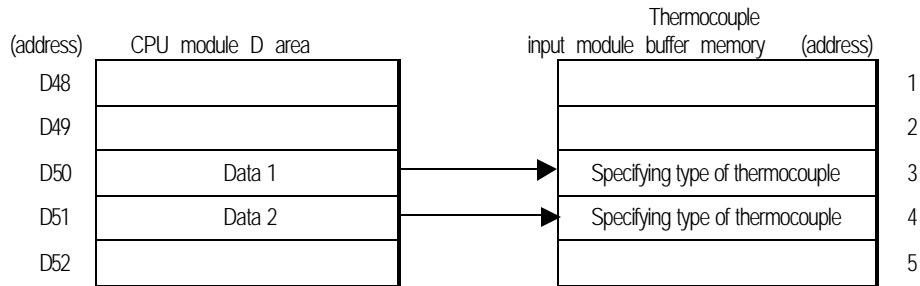

7.2 Remote

7.2.1 Read from Buffer Memory.....RGET

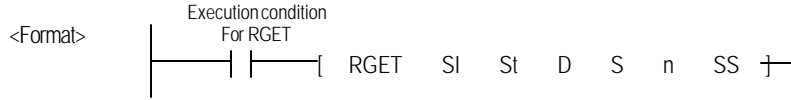

Format	Description	Available data type
SI	Upper(AB) : Code value for thermocouple input module G3F - TC4A : 03h G4F - TC2A : 83h, G6F - TC2A : 23h Lower(CD) : Slot No. of the local communications module(FUEA) Setting range : 0 to 7	Integer
St	Upper(EF) : Slot No. of the thermocouple Input module mounted on the remote station Setting range : 0 to 31 Lower(GH) : Station No. of the communications module mounted on the remote station(RBEA) Setting range : 0 to 63	Integer
D	Head address of the device to store the data read.	M,P,K,L,T,C,D, #D
S	Head address of the specific module buffer memory from the data will be read	Integer
n	Word number of data to be read	Integer, D
SS	Area used for indicating the status information during link	M,P,K,L,T,C,D, #D

**REMARK**

If a content is read from the buffer memory of the thermocouple input module by use of RGET, be sure to make the program so that execution condition can transit from 0 to 1(Rising Edge : ) . Otherwise, the content in the buffer memory of the thermocouple input module is unreadable.

<Example>

[Configuration]

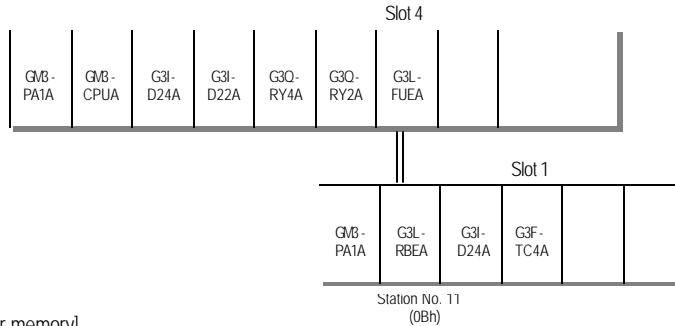

[Read from buffer memory]

- 1) The content in the buffer memory address 17(one word) is read, where the temperature conversion value of the channel 0 of the thermocouple input module had been started
- 2) The data read is stored to D17
- 3) Information on the communications status is stored to D1

[Program]

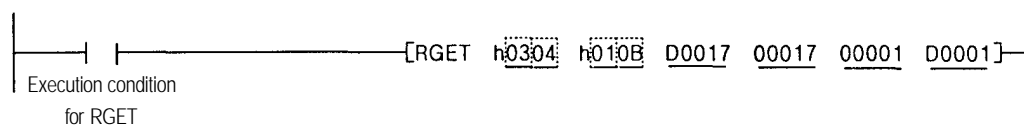

7.2.2 Write to buffer memory ..... RPUT

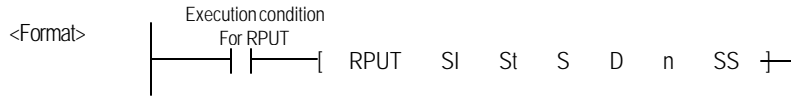

Format	Description	Available data type
SI	Upper(AB): Code value for thermocouple input module G3F - TC4A : 03h G4F - TC2A : 83h ,G6F - TC2A : 23h Lower(CD) : Slot No. of the local communications module(FUEA) Setting range : 0 to 7	Integer
St	Upper(EF) : Slot No. of the thermocouple Input module mounted on the remote station Setting range : 0 to 31 Lower(GH) : Station No. of the communications module mounted on the remote station(RBEA) Setting range : 0 to 63	Integer
S	Head address of the device to be stored the data write.	M,P,K,L,T,C,D, #D
D	Head address of the specific module's head address to write data	Integer
n	Word number of data to be write	Integer, D
SS	Area used for indicating the status information during link	M,P,K,L,T,C,D, #D

**REMARK**  
 If the content is write to the buffer memory of the thermocouple input module by use of RPUT, be sure to make the program so that execution condition can transit from 0 to 1(Rising Edge : ) Otherwise, the content in the buffer memory of the thermocouple input module will not be changed with a new data.

<Example>  
 [Configuration]

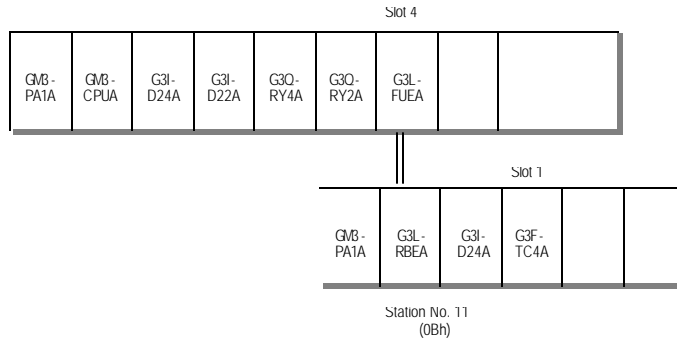

[Write to buffer memory]

- 1) The content in the D100 to D116(17 words) of the devices in the CPU module
- 2) is written to addresses 0 to 16 of the buffer memory of the thermocouple input module, and
- 3) Information on the communication status is stored to D0

[Program]

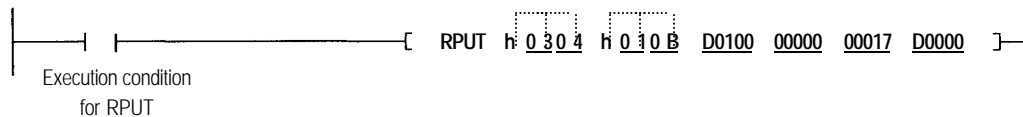

## Chapter 8. PROGRAMMING

### 8.1 Basic Programming

- ▶ The following describes the method to set the running conditions in the buffer memories of the thermocouple-input module.
- ▶ The thermocouple input module is already mounted on the slot 2.
- ▶ The thermocouple input module occupies 16 I/O points.

#### 8.1.1 G3F-TC4A

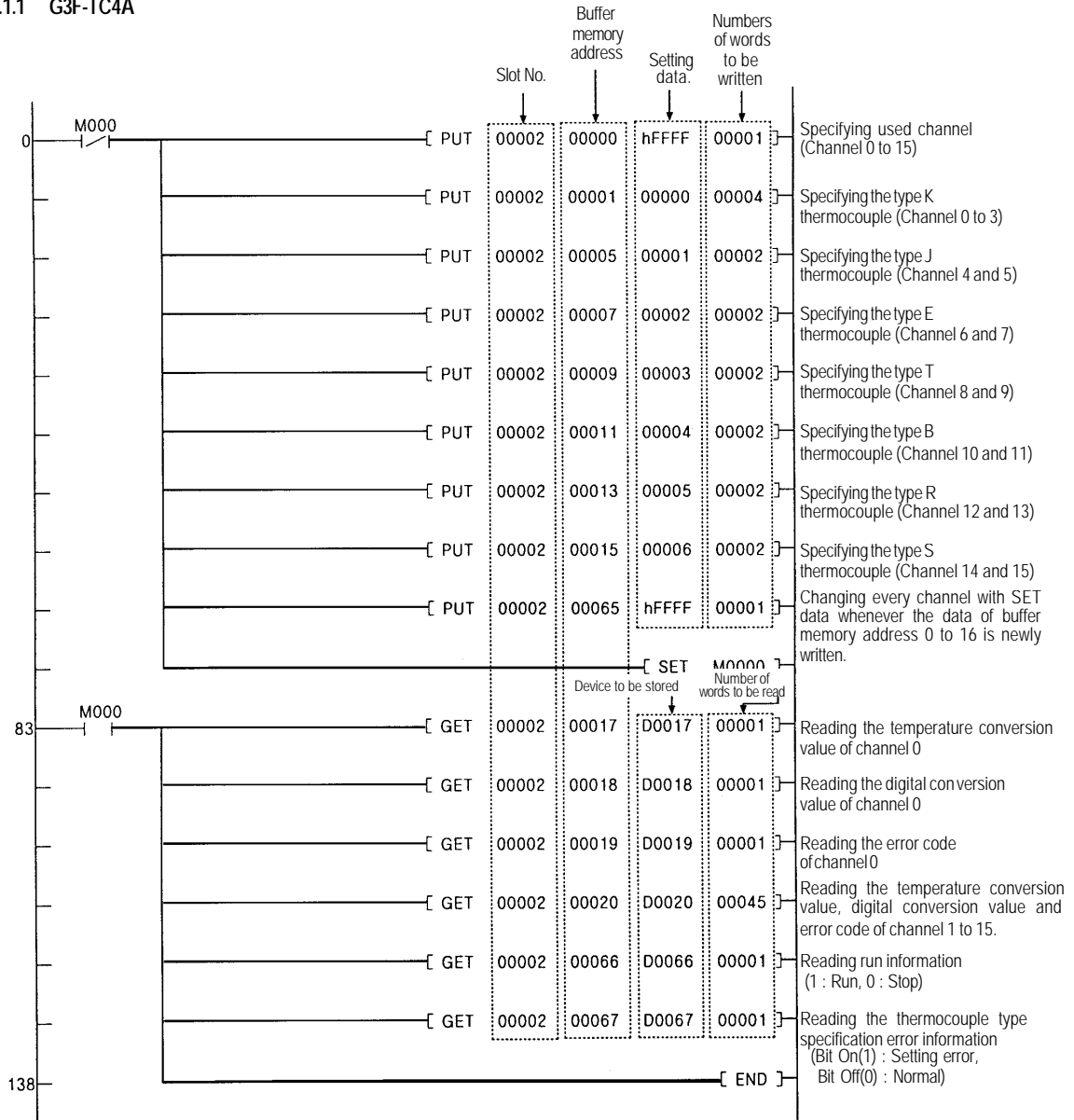

8.1.2 G4F-TC2A

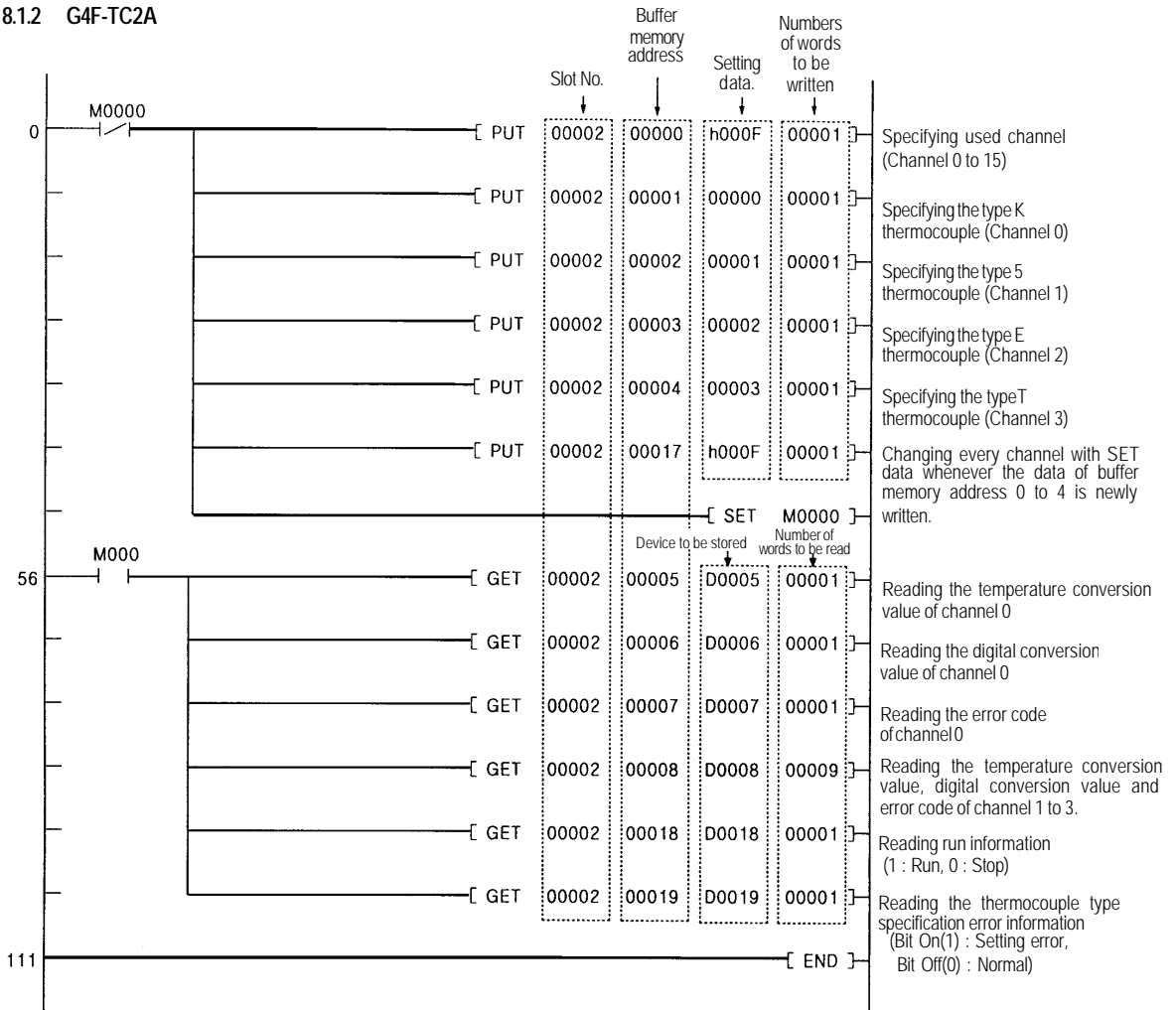

8.1.3 G6F-TC2A

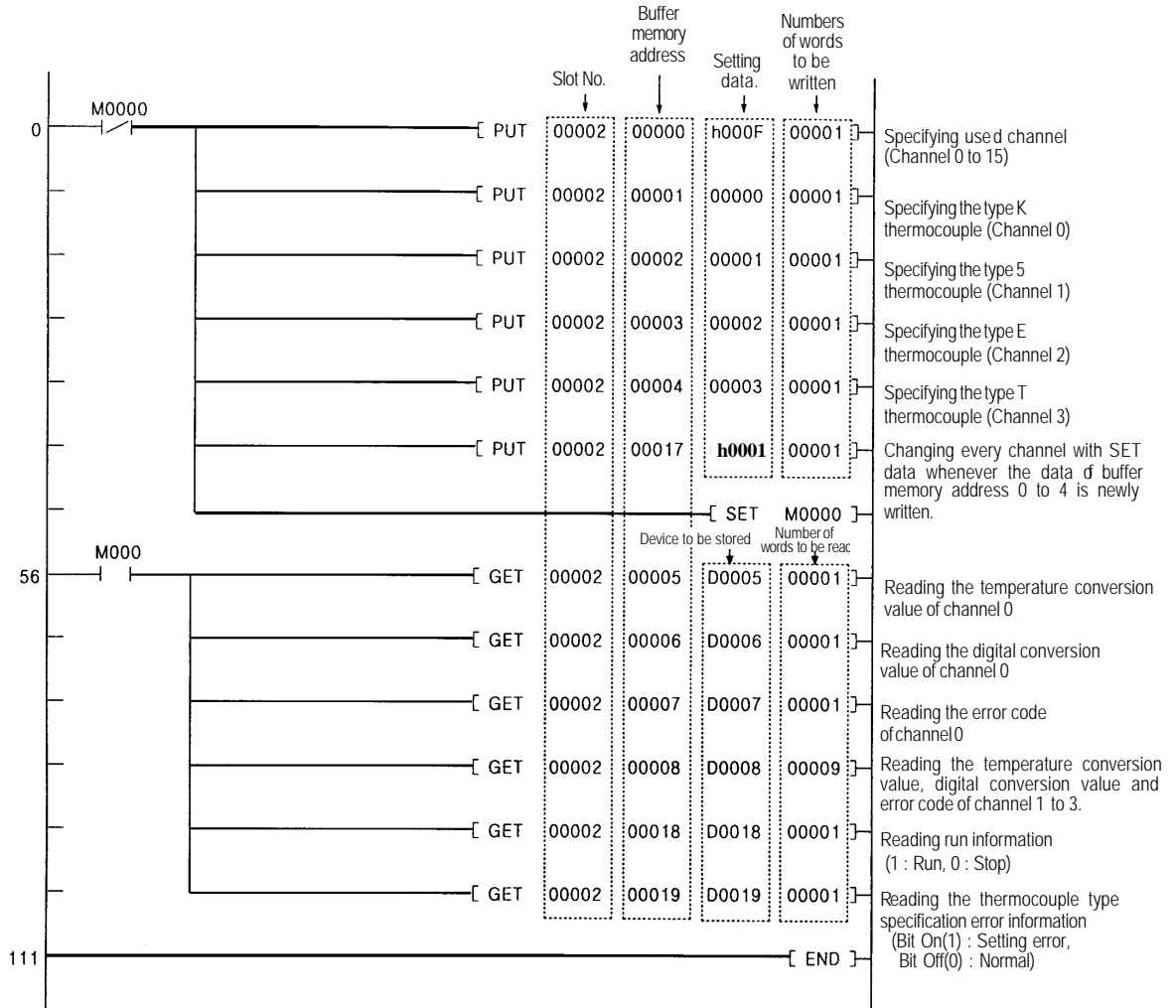

## 8.2 Application Programming

### 8.2.1 A program for Converting a Detected Temperature Value(°C) into Fahrenheit(°F) and Outputting as a BCD Value

#### 1) System

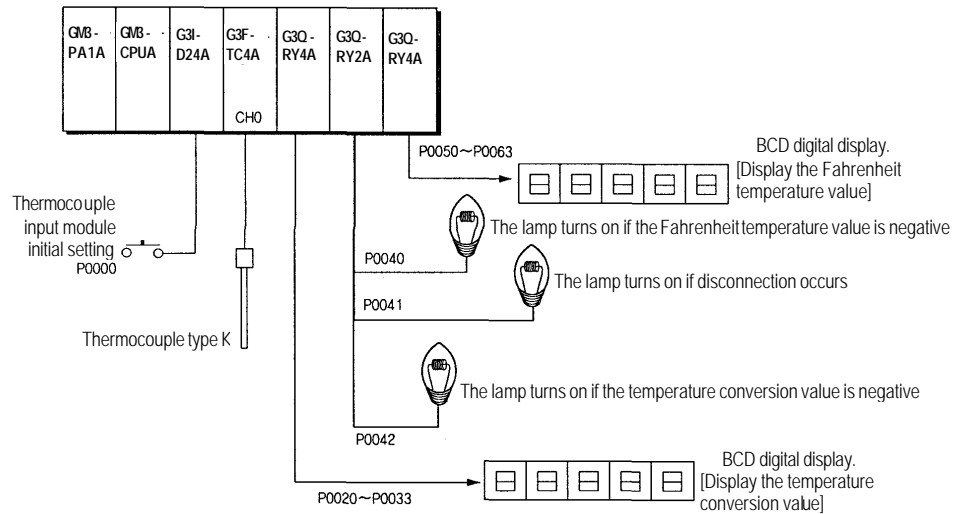

#### 2) Initial Setting

- (1) Specifying used channel : Channel 0
- (2) Specifying the type of the thermocouple : Type K

#### 3) Expression for conversion of a temperature conversion value into a Fahrenheit temperature(°F)

$$\begin{aligned}
 \text{Temperature conversion value} &= \text{Detected temperature value} \times 10 \\
 \text{Fahrenheit temperature(°F)} &= \text{Detected temperature value} \times 1.8 + 32 \\
 &= \frac{\text{Temperature conversion value}}{10} \times 1.8 + 32 \\
 &= \frac{\text{Temperature conversion value} \times 18 + 320}{10}
 \end{aligned}$$

#### 4) Program Description

- (1) If P0000 turns on then the thermocouple input module would be initialized.
- (2) The temperature conversion value is displayed on the BCD digital display of P0020 to P0033. If the value is negative the ramp P0042 will turn on.
- (3) After the conversion of the temperature conversion value into a Fahrenheit temperature (°F), it will be displayed on the BCD digital display of P0050 to P0063. If it is negative the ramp P0040 will turn on.
- (4) If disconnection is detected during conversion of temperature of the channel 0, the ramp P0041 will turn on.

5) Program

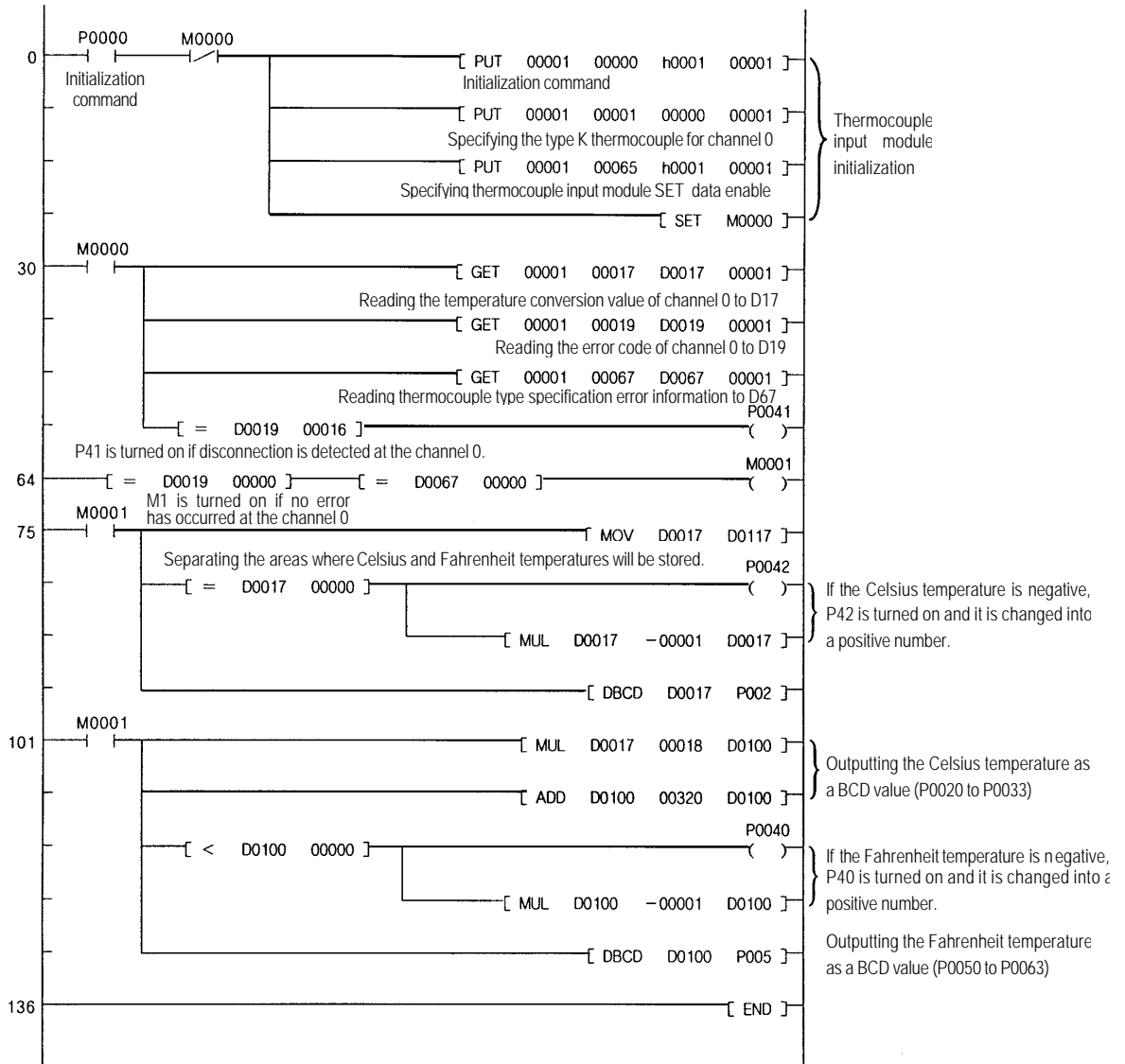

8.2.2 A Program for Magnitude Comparison of a Detected Temperature Value

1) System Configuration

GM3- PA1A	GM3- CPUA	G3F- TC4A	G3Q- RY2A		
--------------	--------------	--------------	--------------	--	--

2) Initial Settings

- (1) Specifying used channel : Channel 0, 1
- (2) Specifying the type of the thermocouple : Type K

3) Program Description

- (1) If the temperature that is input through the channel 0 of the thermocouple input module is less than  $-20^{\circ}\text{C}$  or larger than  $-30^{\circ}\text{C}$ , P0010 turns on.
- (2) If the temperature that is input through the channel 1 of the thermocouple input module is less than  $-20^{\circ}\text{C}$  or larger than  $-30^{\circ}\text{C}$ , P0011 turns on.
- (3) If the difference between the two temperatures that are input through the channel 0 and 1 is larger than  $5^{\circ}\text{C}$ , P0012 turns on.

4) Program

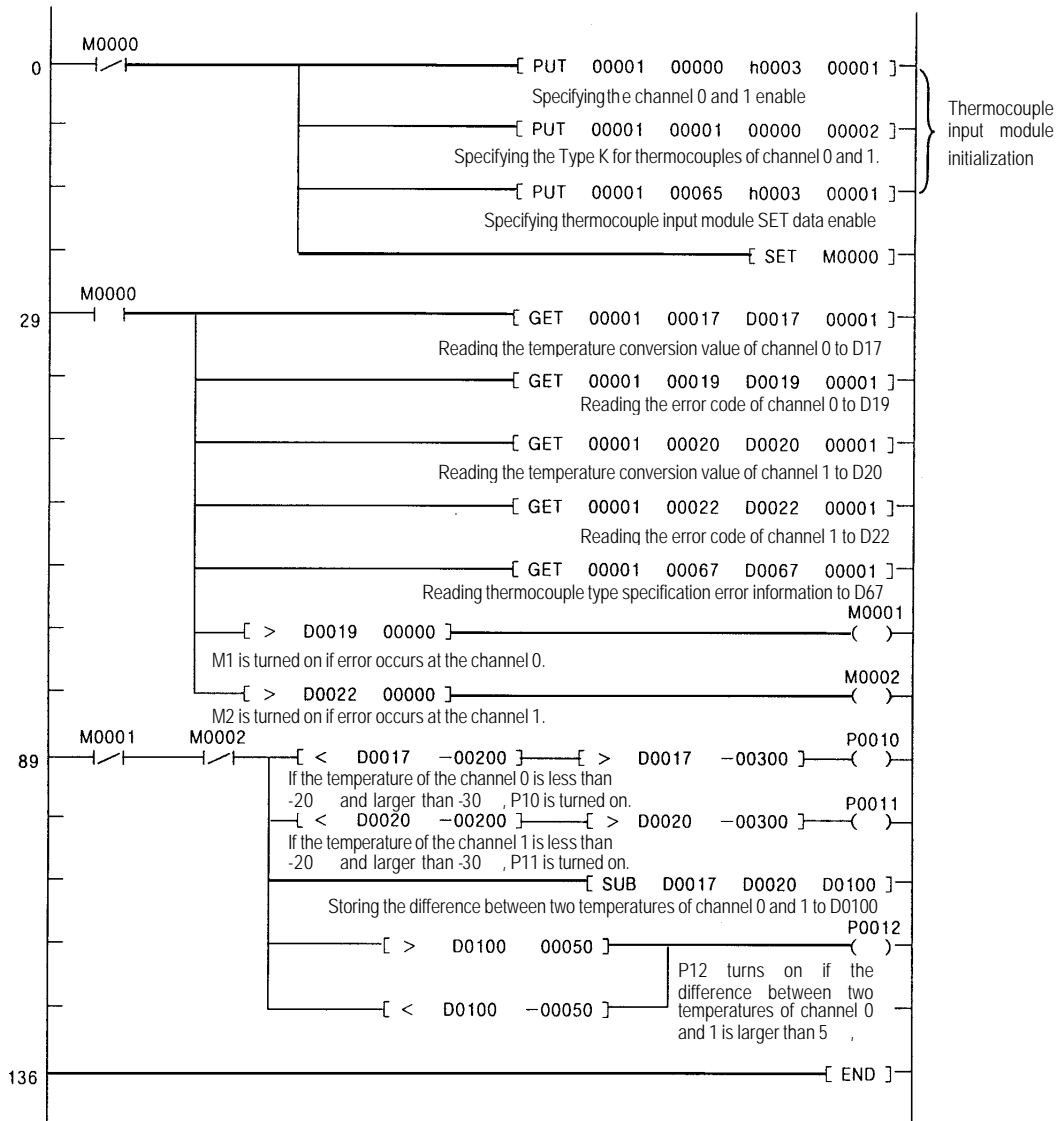

8.2.3 A Program Used When Mounting a Thermocouple Input Module on the Remote I/O Station

1) System Configuration

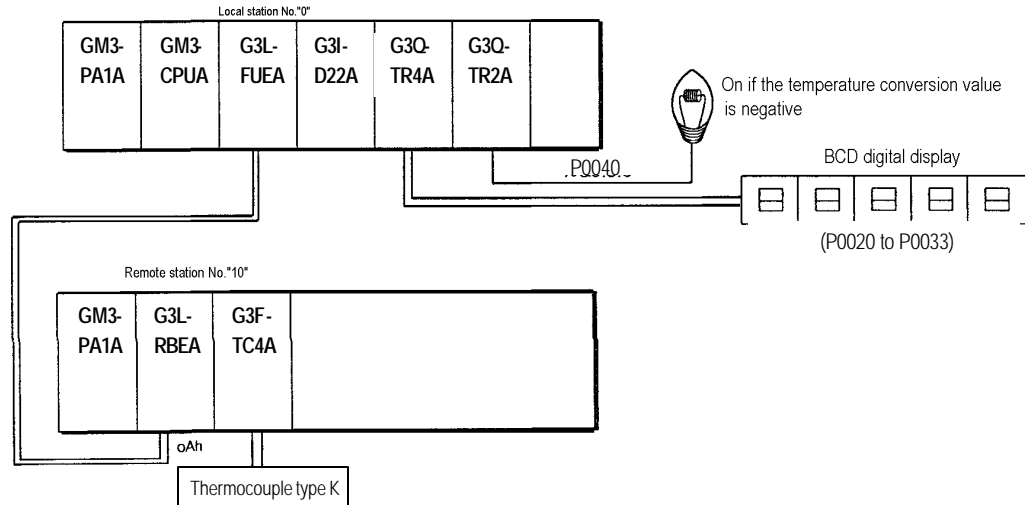

2) Initial Settings

- (1) Specifying used channel : Channel 0
- (2) Specifying the type of the thermocouple : Type K

3) Program Description

- (1) P0040 will be turned on if the temperature conversion value is negative and the value will be converted into positive.
- (2) If no error occurs, the temperature conversion value will be output to P0020 to P0033.



## Chapter 9. TROUBLESHOOTING

The followings explain errors that could occur during operating the thermocouple input module and their troubleshooting.

### 9.1 Errors Indicated by RUN LED Flickering

Errors indicated by the thermocouple input module RUN LED flickering are given below.

RUN LED Status	Error Type	Remark
Flickering (cycle: 0.1 sec)	WDT error	
Flickering (cycle: 0.2 sec)	System error	
	Buffer memory error	
Flickering (cycle: 0.6 sec)	A/D conversion error	
Flickering (cycle: 1.0 sec)	Disconnection	
Flickering (cycle: 1.0 sec)	Outside the upper or lower bound of the range	The data before error has occurred is retained
Flickering (cycle: 1.0 sec)	Reference junction compensation device error	The data before error has occurred is retained

### 9.2 Troubleshooting Procedure

#### 9.2.1 RUN LED Flickering

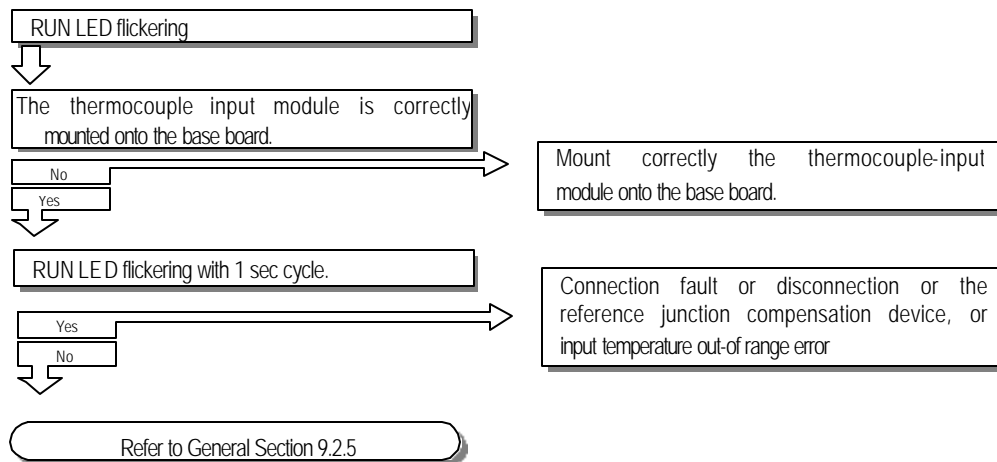

9.2.2 RUN LED Off

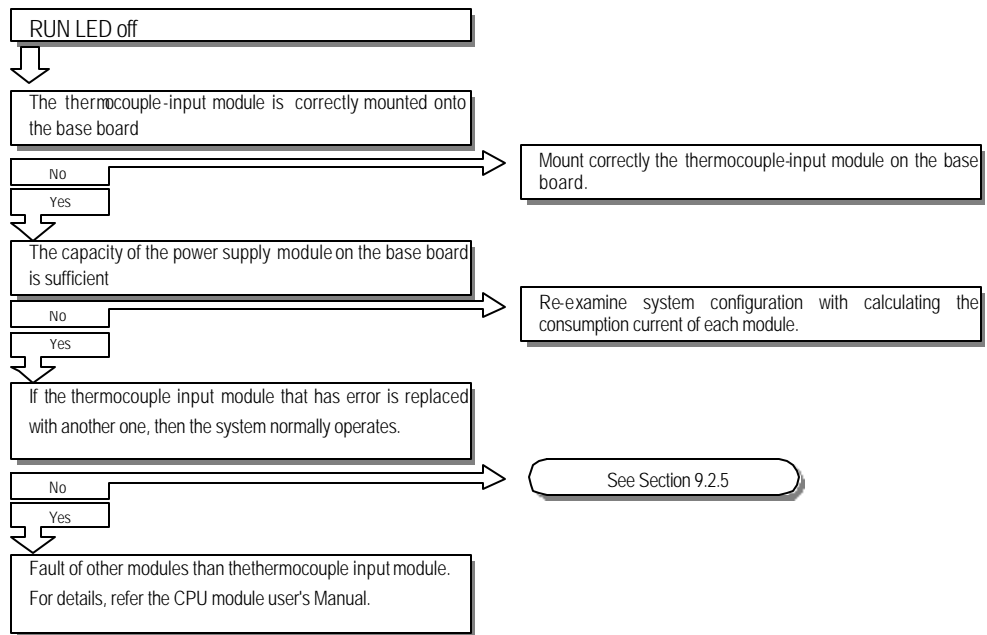

9.2.3 Temperature Conversion Value Fluctuates Excessively

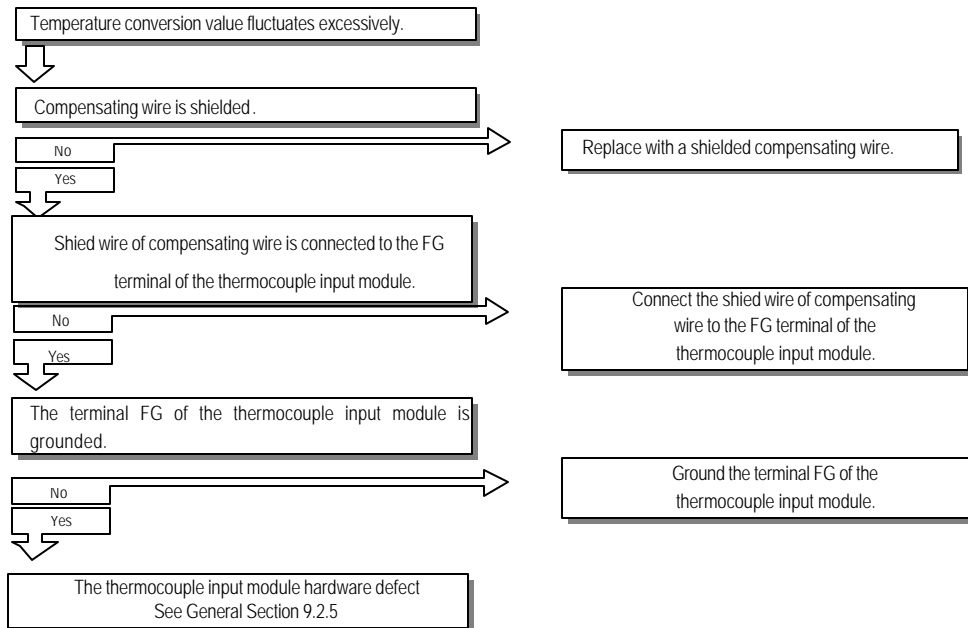

9.2.4 Input Value of the Thermocouple does not Correspond to the Detected Temperature Value.

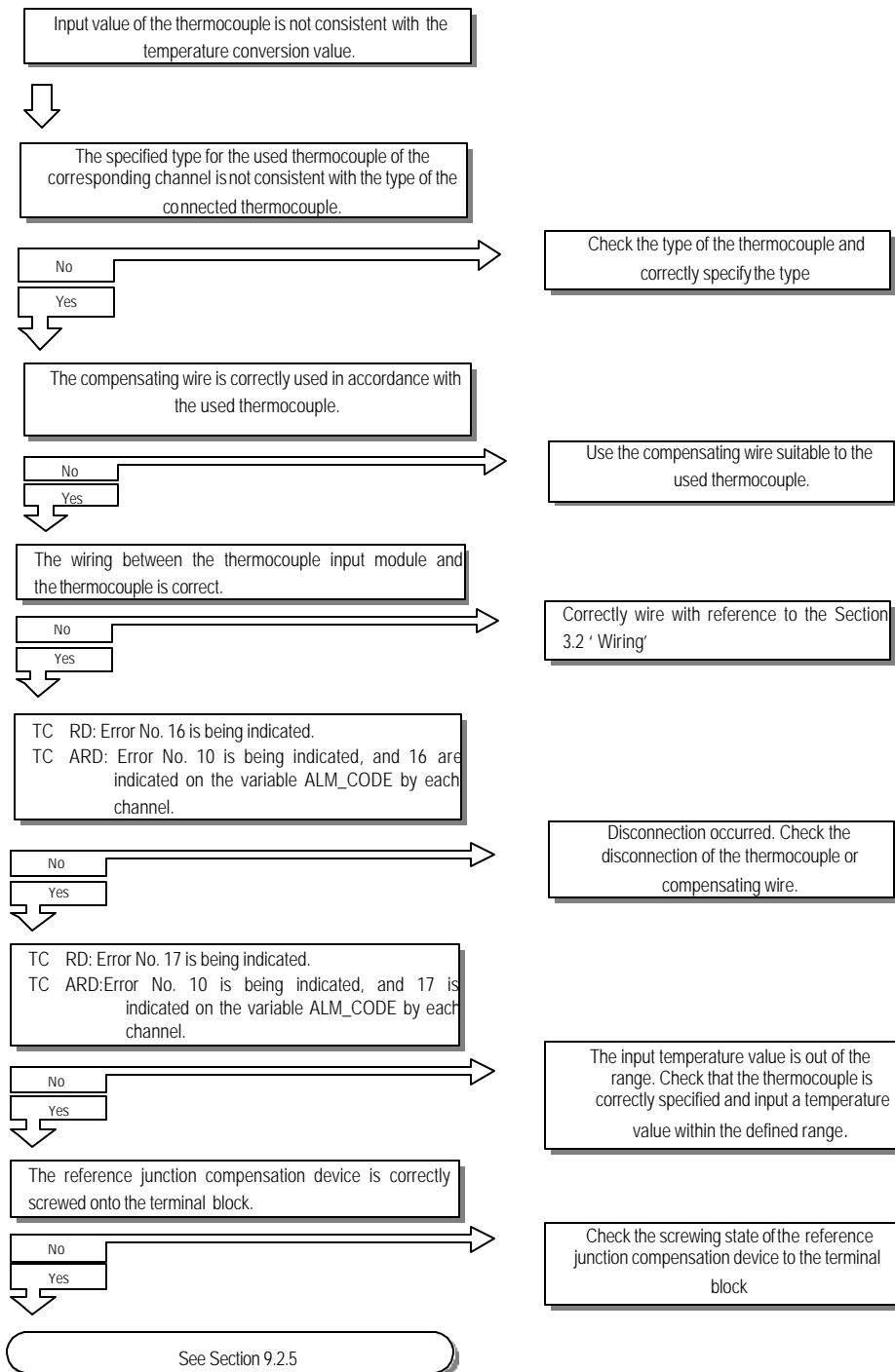

9.2.5 Thermocouple Input Module Hardware Defect

Thermocouple input module hardware defect.  
Contact the nearest agency or service station

# Chapter 10. DIMENSIONS

## 10.1 G3F-TC4A Dimensions.

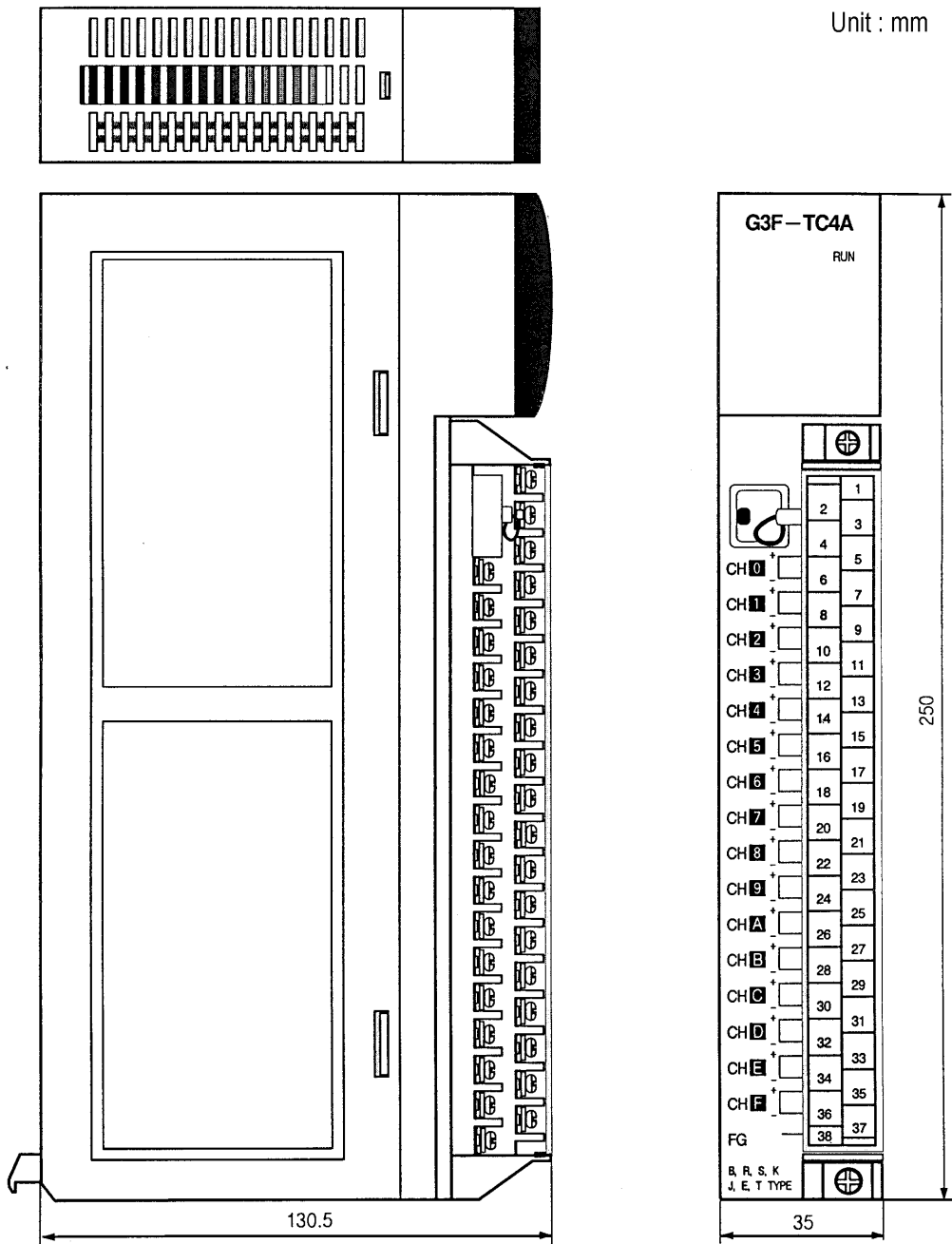

10.2 G4F-TC2A Dimensions

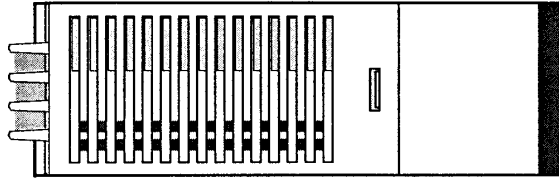

Unit : mm

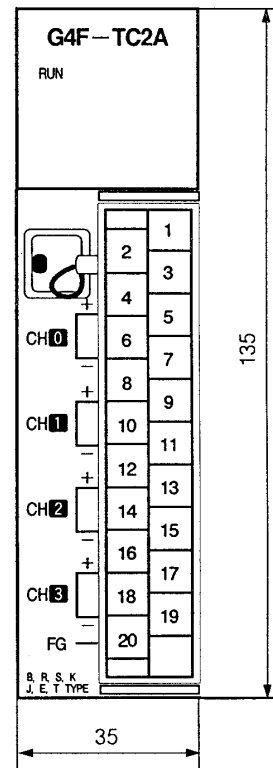
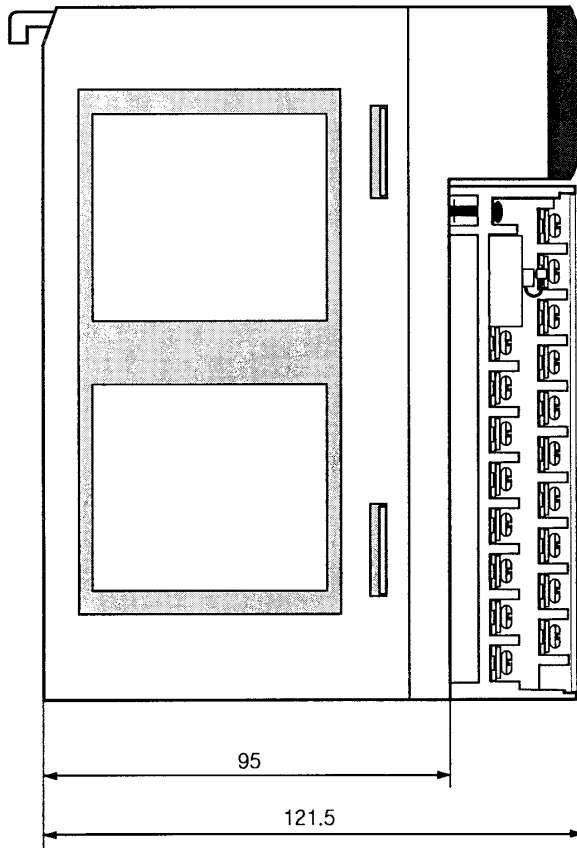

10.3 G6F-TC2A Dimensions.

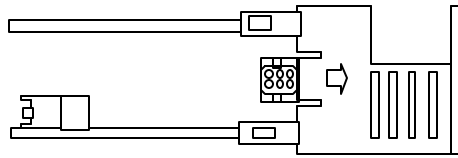

Unit:mm

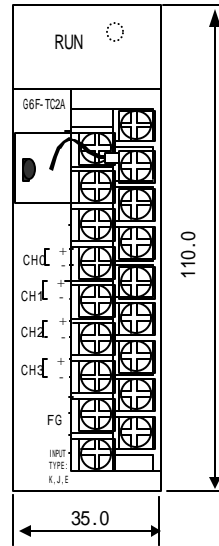
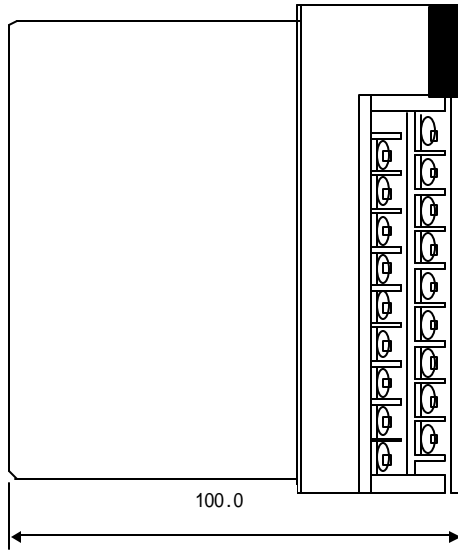

APPENDIX 1.

**1.1 Thermoelectromotive Force Tables**

► Standard thermoelectromotive force tables for type K thermocouples

Unit :  $\mu\text{V}$

-200	-100	-0	Temp. ( )	Temp. ( )	0	100	200	300	400	500	600	700	800	900	1000	1100	1200
-5891	-3553	-0	-0	0	0	4095	8137	12207	16395	20640	24902	29128	33277	37325	41269	45108	48828
	-3852	-392	-10	10	397	4508	8537	12623	16818	21066	25327	29547	33686	37724	41657	45486	
	-4138	-777	-20	20	798	4919	8938	13039	17241	21493	25751	29965	34095	38122	42045	45863	
	-4410	-1156	-30	30	1203	5327	9341	13456	17664	21919	26176	30383	34502	38519	42432	46238	
	-4669	-1527	-40	40	1611	5733	9745	13874	18088	22346	26599	30799	34909	38915	42817	46612	
	-4912	-1889	-50	50	2022	6137	10151	14292	18513	22772	27022	31214	35314	39310	43202	46985	
	-5141	-2243	-60	60	2436	6539	10560	14712	18938	23198	27445	31629	35718	39703	43585	47356	
	-5354	-2586	-70	70	2850	6939	10969	15132	19363	23624	27867	32042	36121	40096	43968	47726	
	-5550	-2920	-80	80	3266	7338	11381	15552	19788	24050	28288	32455	36524	40488	44349	48095	
	-5730	-3242	-90	90	3681	7737	11793	15974	20214	24476	28709	32866	36925	40879	44729	48462	

► Standard thermoelectromotive force tables for type J thermocouples

-200	-100	-0	Temp. ( )	Temp. ( )	0	100	200	300	400	500	600	700	800
-7890	-4632	0	-0	0	0	5268	10777	16325	21846	27388	33096	39130	45498
	-5036	-501	-10	10	507	5812	11332	16879	22397	27949	33683	39754	
	-5426	-995	-20	20	1019	6359	11887	17432	22949	28511	34273	40382	
	-5801	-1481	-30	30	1536	6907	12442	17984	23501	29075	34867	41013	
	-6159	-1960	-40	40	2058	7457	12998	18537	24054	29642	35464	41647	
	-6499	-2431	-50	50	2585	8008	13553	19089	24607	30210	36066	42283	
	-6821	-2892	-60	60	3115	8560	14108	19640	25161	30782	36671	42922	
	-7122	-3344	-70	70	3649	9113	14663	20192	25716	31356	37280	43563	
	-7402	-3785	-80	80	4186	9667	15217	20743	26272	31933	37893	44207	
	-7659	-4215	-90	90	4725	10222	15771	21295	26829	32513	38510	44852	

APPENDIX 1.

► Standard thermoelectromotive force tables for type E thermocouples

Unit :  $\mu\text{V}$

-200	-100	-0	Temp.( )	Temp.( )	0	100	200	300	400	500	600
-8824	-5237	0	-0	0	0	6317	13419	21033	28943	36999	45085
	-5680	-581	-10	10	591	6996	14161	21814	29744	37808	
	-6107	-1151	-20	20	1192	7683	14909	22597	30546	38617	
	-6516	-1709	-30	30	1801	8377	15661	23383	31350	39426	
	-6907	-2254	-40	40	2419	9078	16417	24171	32155	40236	
	-7279	-2787	-50	50	3047	9787	17178	24961	32960	41045	
	-7631	-3306	-60	60	3683	10501	17942	25754	33767	41853	
	-7963	-3811	-70	70	4329	11222	18710	26549	34574	42662	
	-8273	-4301	-80	80	4983	11949	19481	27345	35382	43470	
	-8561	-4777	-90	90	5646	12681	20256	28143	36190	44278	

► Standard thermoelectromotive force tables for type T thermocouples

-200	-100	-0	Temp.( )	Temp.( )	0	100	200	300	400
-5603	-3378	0	-0	0	0	4277	9286	14860	20869
	-3656	-383	-10	10	391	4749	9820	15443	
	-3923	-757	-20	20	789	5227	10360	16030	
	-4177	-1121	-30	30	1196	5712	10905	16621	
	-4419	-1475	-40	40	1611	6204	11456	17217	
	-4648	-1819	-50	50	2035	6702	12011	17816	
	-4865	-2152	-60	60	2467	7207	12572	18420	
	-5069	-2475	-70	70	2908	7718	13137	19027	
	-5261	-2788	-80	80	3357	8235	13707	19638	
	-5439	-3089	-90	90	3813	8757	14281	20252	

APPENDIX 1.

► Standard thermoelctromotive force tables for type B thermocouples

Unit :  $\mu\text{V}$

Temp. ( )	400	500	600	700	800	900	1000	1100	1200	1300	1400	1500	1600	1700	1800
0	786	1241	1791	2430	3154	3957	4833	5777	6783	7845	8952	10094	11257	12426	13585
10	827	1292	1851	2499	3231	4041	4924	5875	6887	7953	9065	10210	11374	12543	
20	870	1344	1912	2569	3308	4126	5016	5973	6991	8063	9178	10325	11491	12659	
30	913	1397	1974	2639	3387	4212	5109	6073	7096	8172	9291	10441	11608	12776	
40	957	1450	2036	2710	3466	4298	5202	6172	7202	8283	9405	10558	11725	12892	
50	1002	1505	2100	2782	3546	4386	5297	6273	7308	8393	9519	10674	11842	13008	
60	1048	1560	2164	2855	3626	4474	5391	6374	7414	8504	9634	10790	11959	13124	
70	1095	1617	2230	2928	3708	4562	5487	6475	7521	8616	9748	10907	12076	13239	
80	1143	1674	2296	3003	3790	4652	5583	6577	7628	8727	9863	11024	12193	13354	
90	1192	1732	2363	3078	3873	4742	5680	6680	7736	8839	9979	11141	12310	13470	

► Standard thermoelctromotive force tables for type R thermocouples

Temp. ( )	0	100	200	300	400	500	600	700	800	900	1000	1100	1200	1300	1400	1500	1600	1700
0	0	647	1468	2400	3407	4471	5582	6741	7949	9203	10503	11846	13224	14624	16035	17445	18842	20215
10	54	723	1557	2498	3511	4580	5696	6860	8072	9331	10636	11983	13363	14765	16176	17585	18981	20350
20	111	800	1647	2596	3616	4689	5810	6979	8196	9460	10768	12119	13502	14906	16317	17726	19119	20483
30	171	879	1738	2695	3721	4799	5925	7098	8320	9589	10902	12257	13642	15047	16458	17866	19257	20616
40	232	959	1830	2795	3826	4910	6040	7218	8445	9718	11035	12394	13782	15188	16599	18006	19395	20748
50	296	1041	1923	2896	3933	5021	6155	7339	8570	9848	11170	12532	13922	15329	16741	18146	19533	20878
60	363	1124	2017	2997	4039	5132	6272	7460	8696	9978	11304	12669	14062	15470	16882	18286	19670	21006
70	431	1208	2111	3099	4146	5244	6388	7582	8822	10109	11439	12808	14202	15611	17022	18425	19807	
80	501	1294	2207	3201	4254	5356	6505	7704	8949	10240	11574	12946	14343	15752	17163	18564	19944	
90	573	1380	2303	3304	4362	5469	6623	7826	9076	10371	11710	13085	14483	15893	17304	18703	20080	

APPENDIX 1.

---

► Standard thermoelectromotive force tables for type S thermocouples

Unit :  $\mu\text{V}$

Temp. ( $^{\circ}\text{C}$ )	0	100	200	300	400	500	600	700	800	900	1000	1100	1200	1300	1400	1500	1600	1700
0	0	645	1440	2323	3260	4234	5237	6274	7345	8448	9598	10754	11947	13155	14368	15576	16771	17942
10	55	719	1525	2414	3356	4333	5339	6380	7454	8560	9700	10872	12067	13276	14489	15697	16890	18056
20	113	795	1611	2506	3452	4432	5442	6486	7563	8673	9816	10991	12188	13397	14610	15817	17008	18170
30	173	872	1698	2599	3549	4532	5544	6592	7672	8786	9932	11110	12308	13519	14731	15937	17125	18282
40	235	950	1785	2692	3645	4632	5648	6699	7782	8899	10048	11229	12429	13640	14852	16057	17243	18394
50	299	1029	1873	2786	3743	4732	5751	6805	7892	9012	10165	11348	12550	13761	14973	16176	17360	18504
60	365	1109	1962	2880	3840	4832	5855	6913	8003	9126	10282	11467	12671	13883	15094	16296	17477	18612
70	432	1190	2051	2974	3938	4933	5960	7020	8114	9240	10400	11587	12792	14004	15215	16415	17594	
80	502	1273	2141	3069	4036	5034	6064	7128	8225	9355	10517	11707	12913	14215	15336	16534	17711	
90	573	1356	2232	3164	4135	5136	6169	7236	8336	9470	10635	11827	13034	14247	15456	16653	17826	

**1.2 Thermocouple**

1.2.1 Normal and Overheat Temperature Limits

Material Code	Previous Code (reference)	Wire Diameter (mm)	Normal Temperature Limit (1) °C	Overheat Temperature Limit (2) °C
B	–	0.50	1500	1700
R	–	0.50	1400	1600
S				
K	CA	0.65	650	850
		1.00	750	950
		1.60	850	1050
		2.30	900	1100
		3.20	1000	1200
E	CRC	0.65	450	500
		1.00	500	550
		1.60	550	650
		2.30	600	750
		3.20	700	800
J	IC	0.65	400	500
		1.00	450	550
		1.60	500	650
		2.30	550	750
		3.20	600	750
T	CC	0.32	200	250
		0.65	200	250
		1.00	250	300
		1.60	300	300

**REMARK**

Note (1) : Normal temperature limit refers to the limit temperature for continuous operation of the thermocouple in air.

Note (2) : Overheat temperature limit refers to the limit temperature only available for short period operation in a very necessary condition.

1.2.2 Temperature Tolerances

Material Code	Previous Code (reference)	Measured temperature range °C	Class	Tolerance (1)
B	—	600 to 1700	0.5	± 4 °C or measured temperature ± 0.5%
R S	—	0 to 1600	0.25	± 1.5 °C or measured temperature ± 0.25%
K	CA	0 to 1000	0.4	± 1.5 °C or measured temperature ± 0.4%
		0 to 1200	0.75	± 2.5 °C or measured temperature ± 0.75%
		-200 to 0	1.5	± 2.5 °C or measured temperature ± 1.5%
E	CRC	0 to 800	0.4	± 1.5 °C or measured temperature ± 0.4%
		0 to 800	0.75	± 2.5 °C or measured temperature ± 0.75%
		-200 to 0	1.5	± 2.5 °C or measured temperature ± 1.5%
J	IC	0 to 750	0.4	± 1.5 °C or measured temperature ± 0.4%
		0 to 750	0.75	± 2.5 °C or measured temperature ± 0.75%
T	CC	0 to 350	0.4	± 0.5 °C or measured temperature ± 0.4%
		0 to 350	0.75	± 1 °C or measured temperature ± 0.75%
		-200 to 0	1.5	± 1 °C or measured temperature ± 1.5%

**REMARK**

Note (1) : Tolerance refer to the maximum permitted limit of the difference in temperature between the temperature looked up in a standard thermoelectromotive force table corresponding to the thermoelectromotive force, and the measuring junction temperature.

The tolerance is taken as the large of the temperature (°C) and percentage (%) values.

**1.3 Compensating Wire**

**1.3.1 Types and Specifications of Compensating Wire**

Combined thermocouple		Compensating wire		Class	Material		Operating temperature(° C)	Junction temperature (° C)	Compensating wire error tolerance(W)	Wire dielectrics(W) <sup>(3)</sup>	Color of surface fiber	Color of Core fiber		Remark												
Code	Previous code	Code	Previous code		+ part	- part						+	-		Compensation type											
B R S	-	BX-G	-	General /Normal	Cu	Cu	0 to 90	0 to 100	- (1)	0.05	gray	red	white	compensation type												
		RX-G SX-G		General /Normal	Cu	Cu/Ni alloy	0 to 90	0 to 150							+3 (2) -7	0.1	black	red	white							
		RXH SXH		Heat tolerance /Normal			0 to 150																			
K	CA	KX-G	WCA-G	General /Normal	Ni/Cr alloy	Ni alloy	-20 to 90	-20 to 150	± 2.5	1.5	blue	red	white	expansion type												
		KX-GS	WCA-GS	General /Precision			0 to 150								± 1.5											
		KX-H KX-HS	WCA-H WCA-HS	Heat tolerance /Normal Heat tolerance /Precision			0 to 150								± 2.5 ± 1.5											
		WX-G	WCA-G	General /Normal	Fi	Cu/Ni alloy	-20 to 90								± 3.0	0.5	0.8	compensation type								
		WX-H	WCA-H	Heat tolerance /Normal			0 to 150																			
		VX-G	WCA-G	General /Normal	Cu	Cu/Ni alloy	-20 to 90												-20 to 100							
E	CRC	EX-G	WCRC-G	General /Normal	Ni/Cr alloy	Cu/Ni alloy	-20 to 90	± 2.5	1.5	violet	red	white	expansion type													
		EX-H	WCRC-H	Heat tolerance /Normal			0 to 150																			
J	IC	JX-G	WIC-G	General /Normal	Fi	Cu/Ni alloy	-20 to 90							-20 to 150					± 2.5	0.8	yellow	red	white	expansion type		
		JX-H	WIC-H	Heat tolerance /Normal			0 to 150																			
T	CC	TX-G	WCC-C	General /Normal	Cu	Cu/Ni alloy	-20 to 90								± 2.0	0.8	brown	red							white	expansion type
		TX-GS	-	General /Precision			0 to 150																			
		TX-H	WCC-H	Heat tolerance /Normal			0 to 150	± 2.0																		
		TX-HS	-	Heat tolerance /Precision			0 to 150	± 1.0																		

**REMARK**

Note (1) : The BX-G uses same material core(Cu) on the two parts of + and -. Therefore, error tolerance is not defined.

Note (2) : The thermocouple type R and S's thermoelectromotive force characteristics is non-linear, so it is not real measurement error of temperatures.

Note (3) : This should be applied to the wires of 1.25 mm<sup>2</sup> or more section area.